



SICOP DENTAL CATALOGUE



SICOP

Surgical
Instruments
Co. of Pak



www.sicopinstruments.com

VARITEY HANDLES AT YOUR CHOICE



Code. 1212-01-Hollow S.S



Code. 1212-02-Hollow S.S



Code. 1212-03-Hollow S.S



Code. 1212-04-Hollow S.S



Code. 1212-05-Hollow S.S



Code. 1212-06-Hollow S.S



Code. 1212-07-Hollow S.S



Code. 1212-08-Hollow S.S



Code. 1212-09-Solid S.S



Code. 1212-10-Solid S.S

VARITEY HANDLES AT YOUR CHOICE



Code. 1212-11-Solid S.S



Code. 1212-12-Solid S.S



Code. 1212-13-Solid S.S



Code. 1212-14-Solid S.S



Code. 1212-15-Hollow S.S



Code. 1212-16-Hollow S.S



Code. 1212-17-Solid ALM



Code. 1212-18-Solid ALM



Code. 1212-19-Solid ALM



Code. 1212-20-Solid S.S Pvc



Code. 1212-21-Hollow S.S Pvc

Durable handles offer extremely light weight - Color - code.

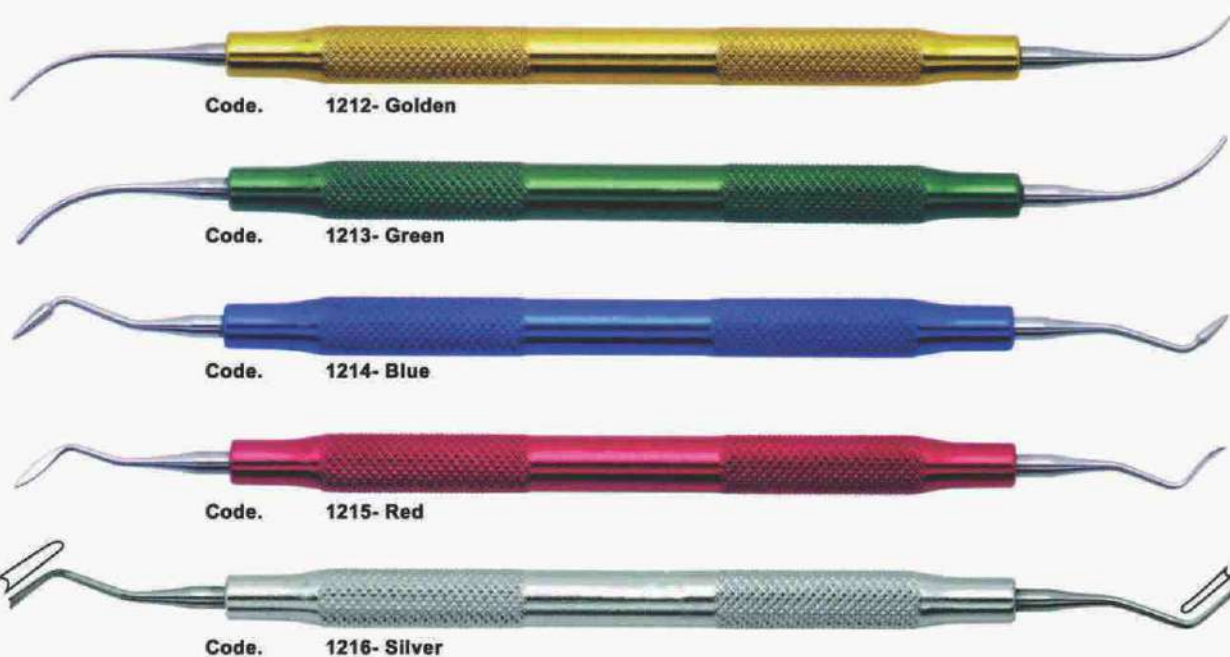

P.K.T.S. Used to remove wax as cusp ridges are developed. Its contour maintains desired convenient at these ridges.

SET OF 8 GRACEY COLOR CODE.





Gracey nr. 1/2 Code. 1225



Gracey nr. 3/4 Code. 1226



Gracey nr. 5/6 Code. 1227



Gracey nr. 7/8 Code. 1228



Gracey nr. 9/10 Code. 1229



Gracey nr. 11/12 Code. 1230



Gracey nr. 13/14 Code. 1231



Gracey nr. 11/14 Code. 1232



Gracey nr. 12/13 Code. 1233

SET OF 7 GRACEY CURETTES.



Gracey nr. 1/2 Code. 1234



Gracey nr. 3/4 Code. 1235



Gracey nr. 5/6 Code. 1236



Gracey nr. 7/8 Code. 1237



Gracey nr. 11/12 Code. 1238



Gracey nr. 13/14 Code. 1239



Gracey nr. 15/16 Code. 1240

SET OF 7 GRACEY COLOR CODE.



Gracey nr. 1/2 Code. 1241



Gracey nr. 3/4 Code. 1242



Gracey nr. 5/6 Code. 1243



Gracey nr. 7/8 Code. 1244



Gracey nr. 9/10 Code. 1245



Gracey nr. 11/12 Code. 1246



Gracey nr. 13/14 Code. 1247

COMPOSITE FILLING INSTRUMENTS S.S BLACK GOLD CODE.



EXG8 Code. 1257



EXG9 Code 1258



EXGK Code 1259



EXG23 Hirtenstab Code. 1260



EXR Code. Wise-1261



EXGR8 Code. 1262



EXR9 Code 1263



EXRK Code 1264



EXR23 Code 1265



EXTUR Code 1266



ENDODONTIC INSTRUMENTS



Size 0 Code. 1267 Size 1 Code. 1268 Size 2 Code. 1269 Size 3 Code. 1270 Size 4 Code. 1271 Size 5 Code. 1272 Size 6 Code. 1273 Size 7 Code. 1274 Size 8 Code. 1275 Size 9 Code. 1276

PROBES. EXPLORERS



nr. 6 - mm 6 Code. 1277

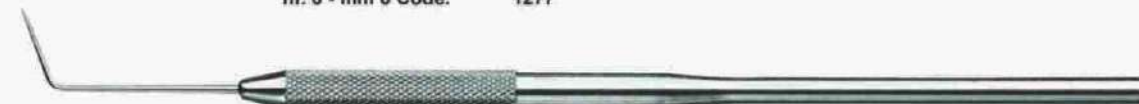

nr. 6A - mm 11 Code. 1278



nr. 6L - mm 9 Code. 1279



nr. 8 - mm 10 Code. 1280

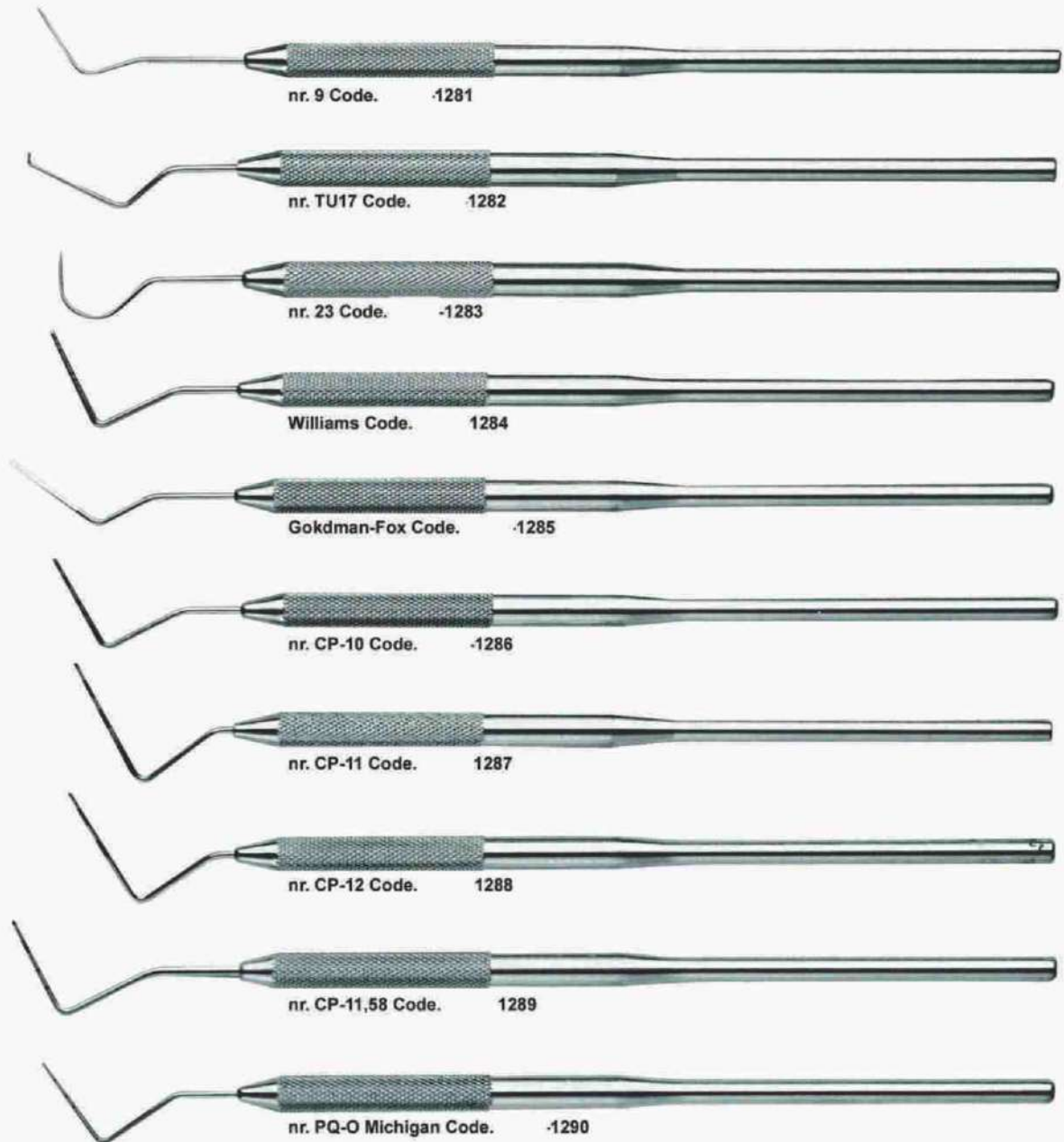

PROBES. EXPLORERS





PROBES & EXPLORERS

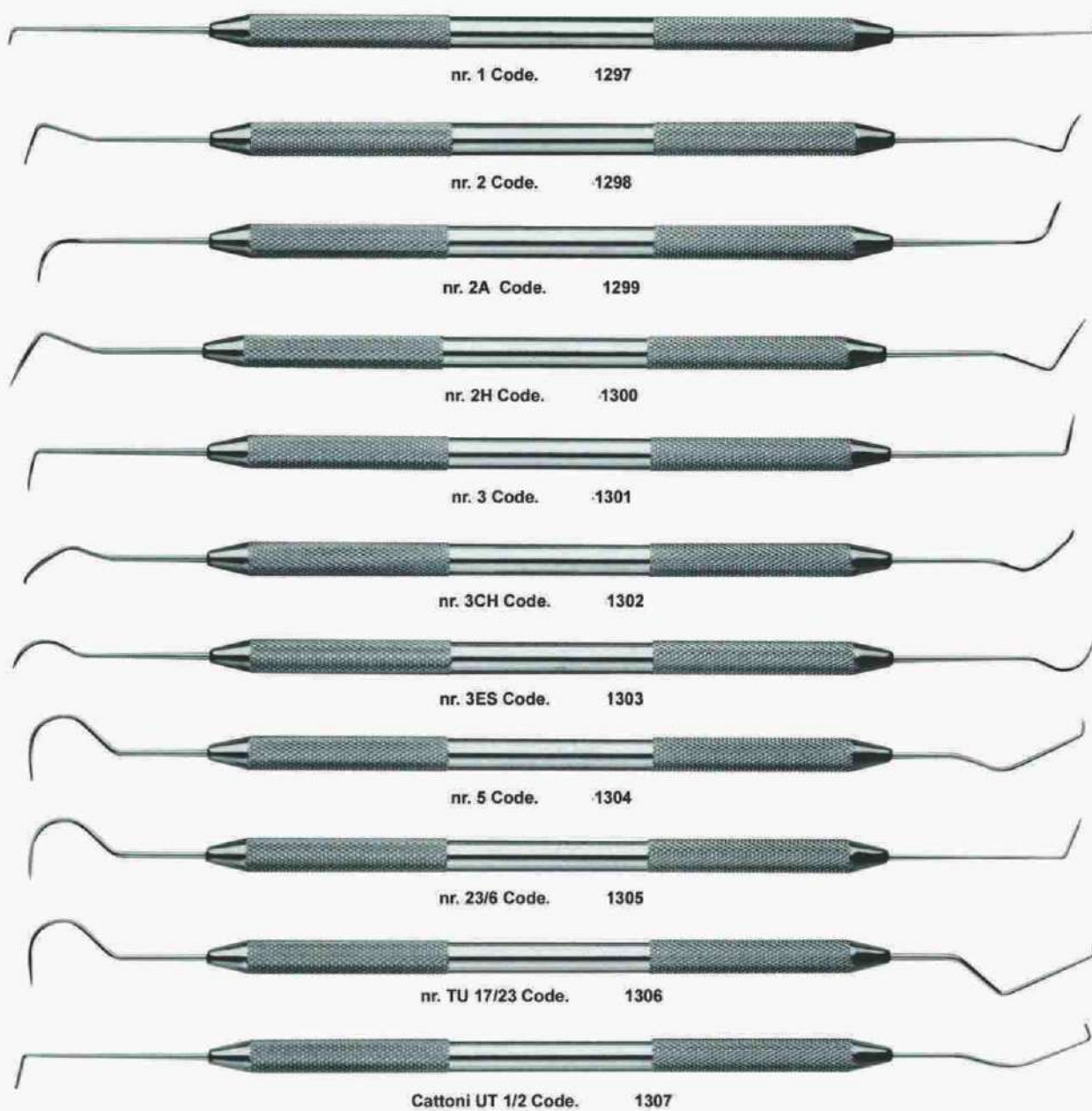



PROBES EXPLORERS COLOR CODE

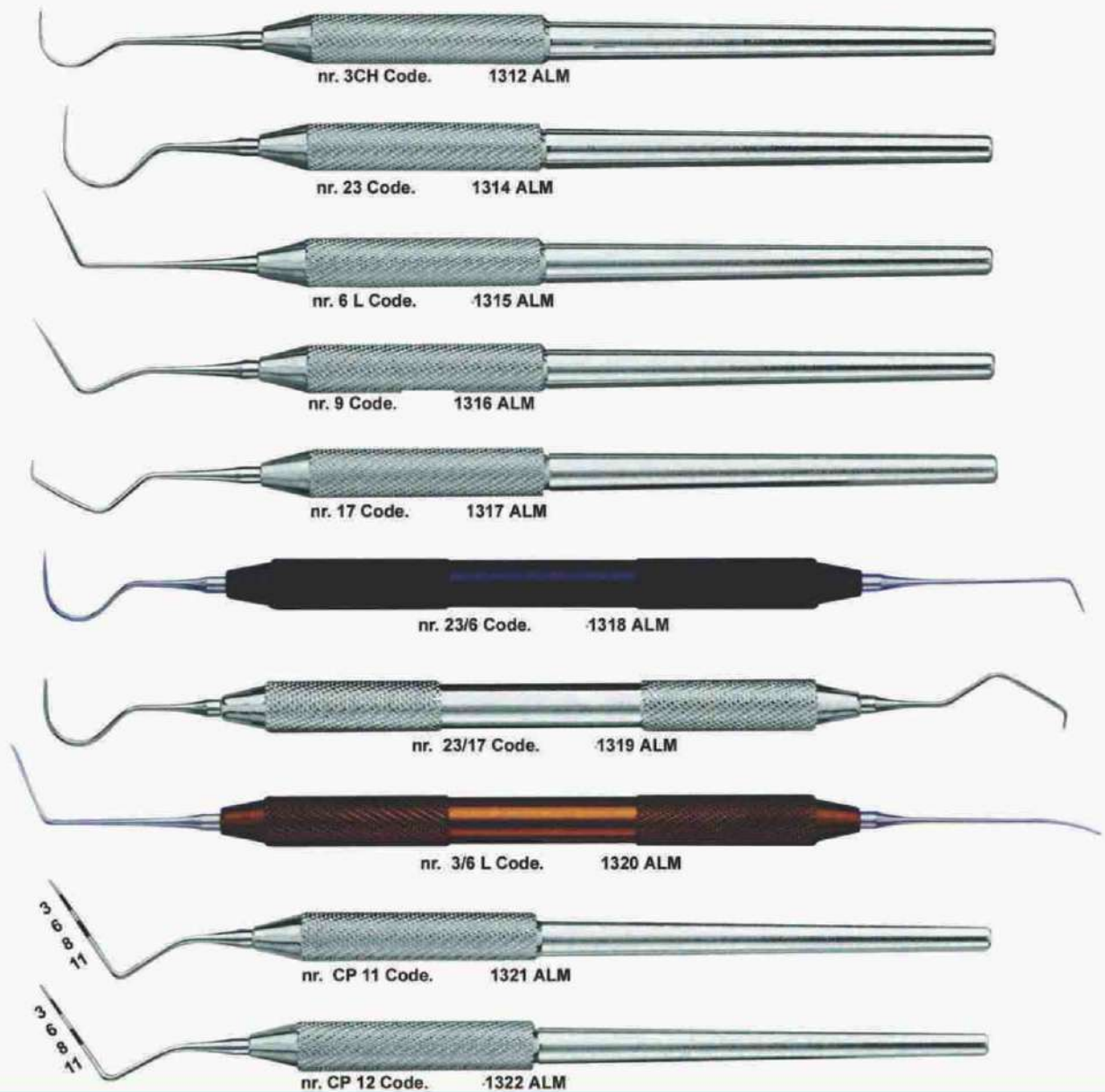



Millimetrata nr. 23/CP 11 Code. 1323 ALM

Plugger 1/2 Code. 1323-A- ALM

PROBES & EXPLORERS

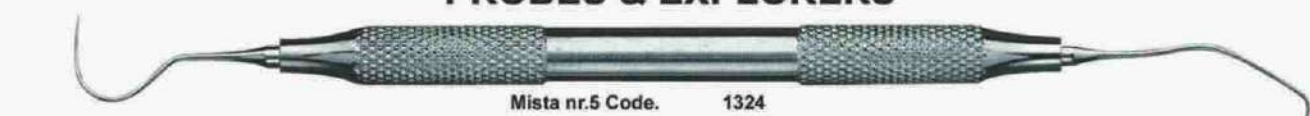

Mista nr.5 Code. 1324



Mista nr.6 Code. 1325



Mista nr.23/6 Code. 1326



Mista nr.23/17 Code. 1327



Mista nr. UT 1/2 Code. 1328

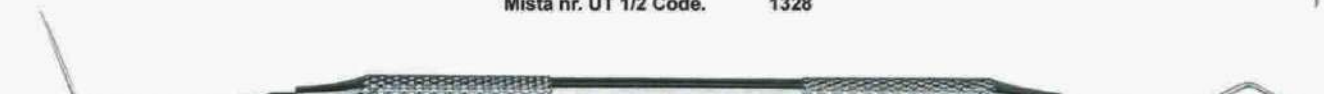

Mista nr. 16 Code. 1329



Nabers nr. 1N Code. 1330



Nabers nr. 2N Code. 1331



Interrossimale nr. 2 Code. 1332



Interrossimale nr. 2A Code. 1333



Interrossimale nr. 3 Code. 1334

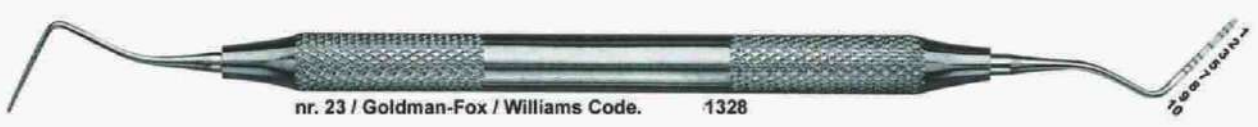

SPREADERS



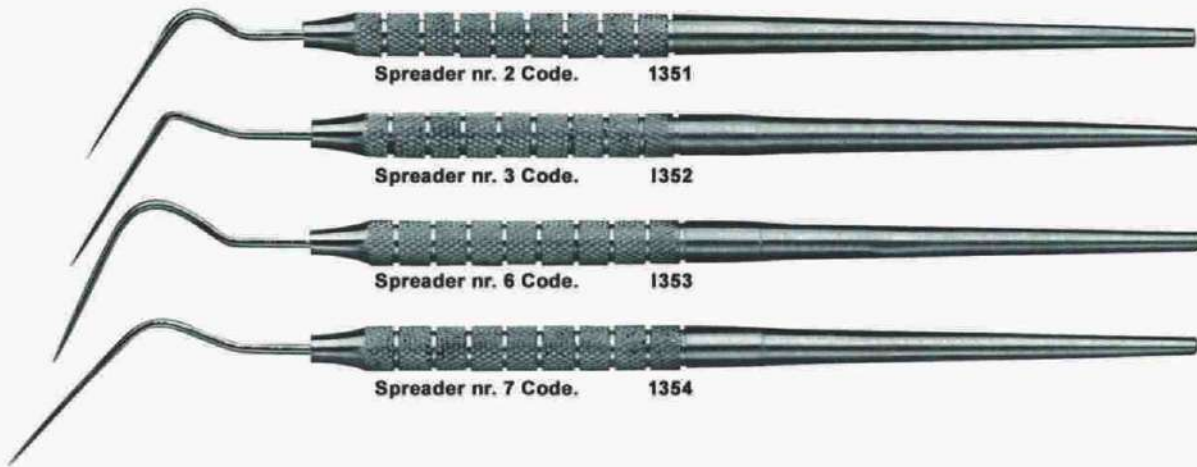

PLUGGERS

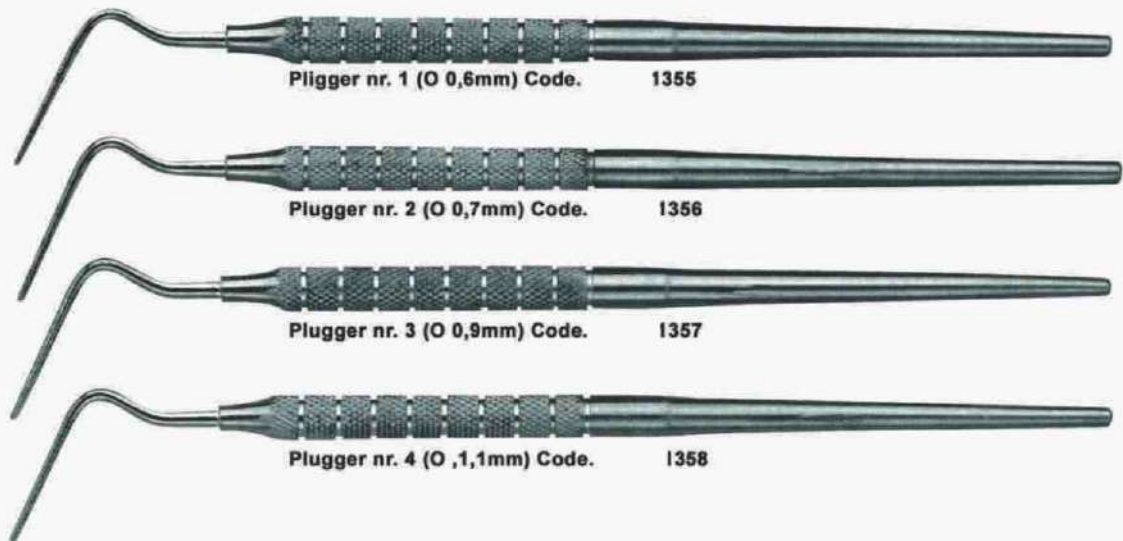

PLUGGERS

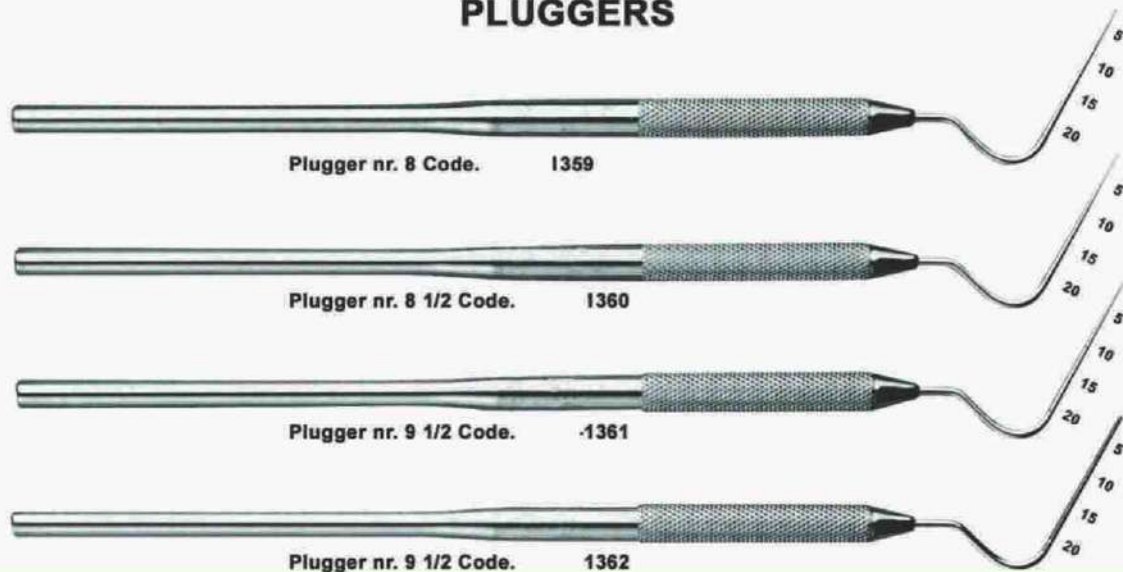

ROOT CANAL PLUGGER

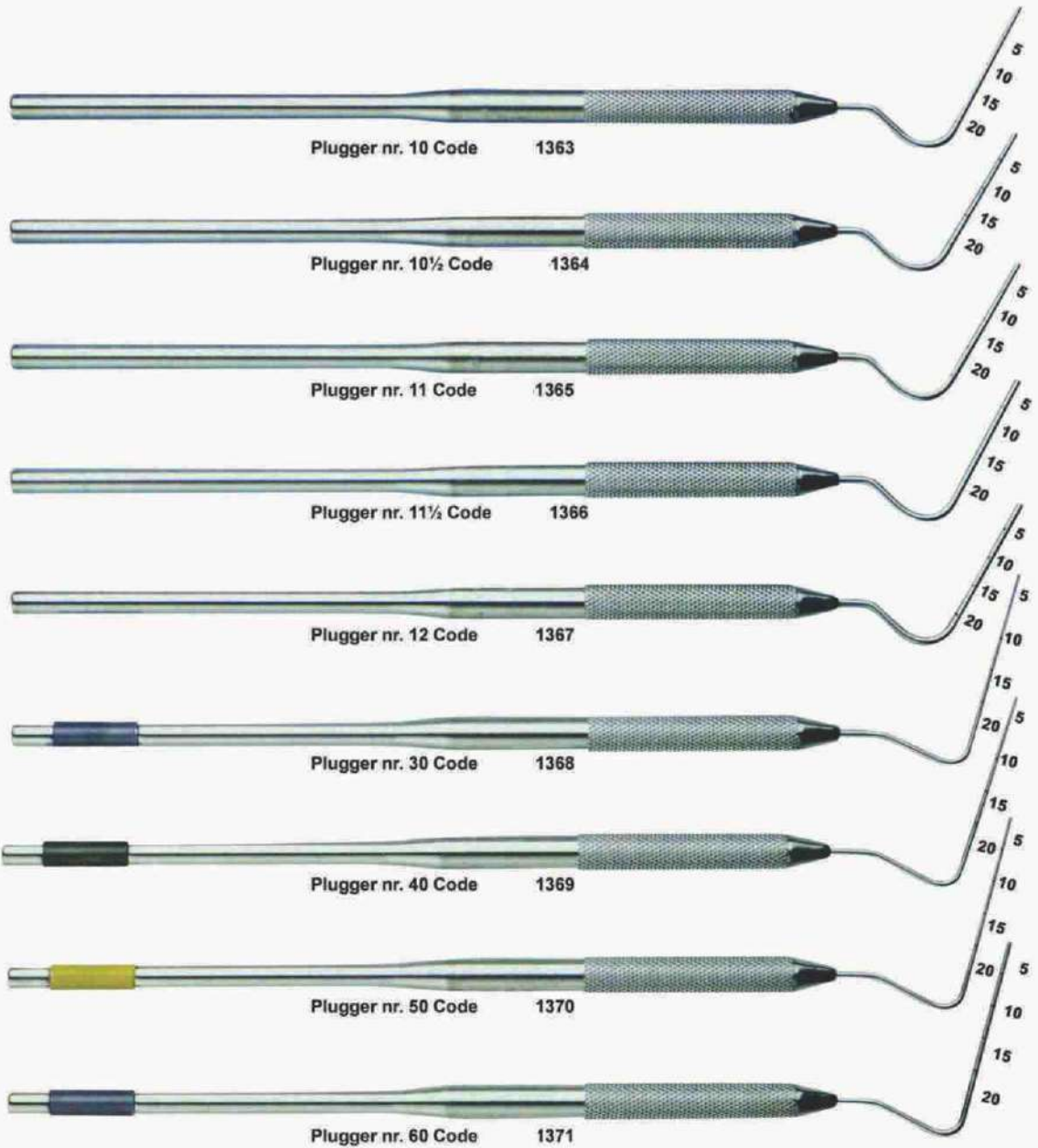

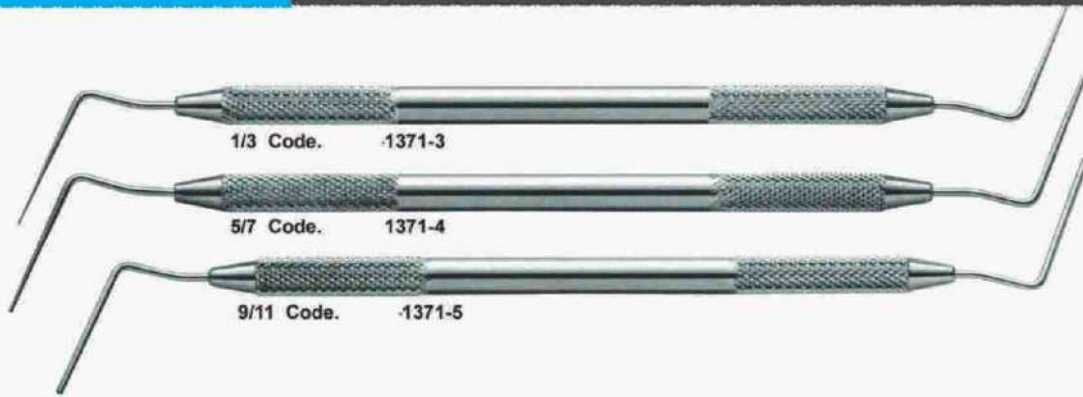

ESCAVATORES

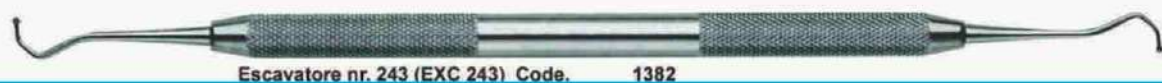
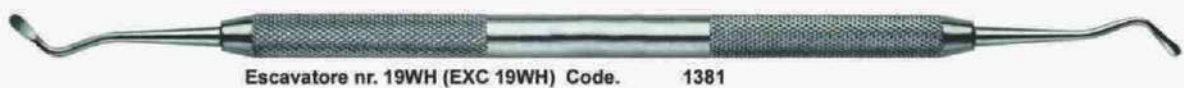
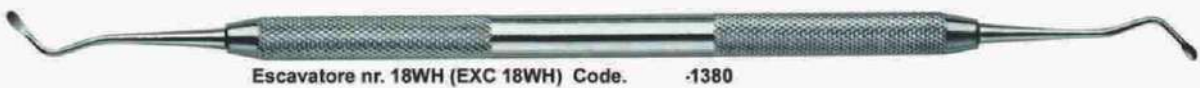
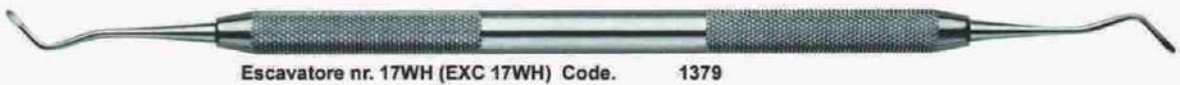
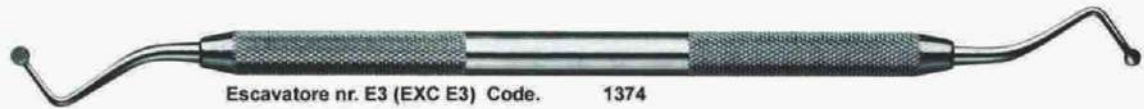
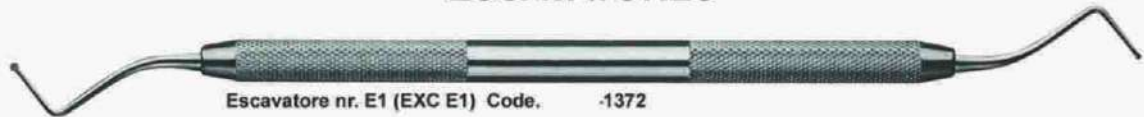

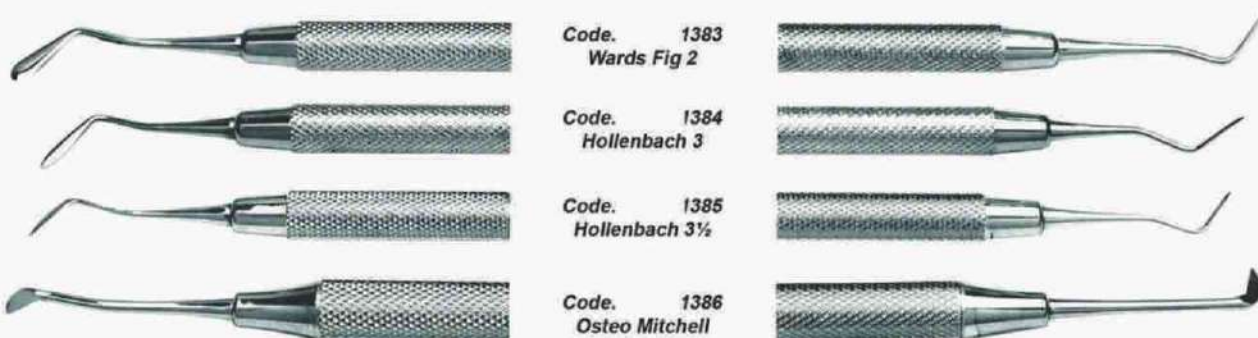

Code. 1383
Wards Fig 2

Code. 1384
Hollenbach 3

Code. 1385
Hollenbach 3½

Code. 1386
Osteo Mitchell

ESCAVATORES



Escavatore endodontico nr. 1 C Code. 1387

Escavatore endodontico nr. 2 C Code. 1388

Escavatore a unghietta nr. 1 Code. 1389

Escavatore a unghietta nr. 2 Code. 1390

Escavatore a unghietta nr. 3 Code. 1391

HEIDEMANN SPATULAS

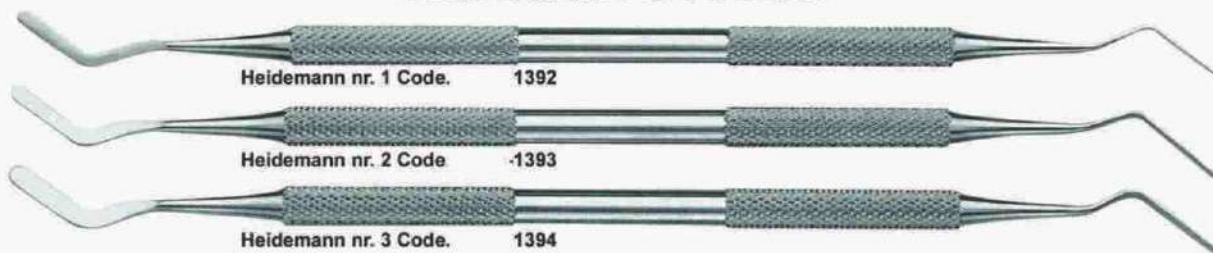

Heidemann nr. 1 Code. 1392

Heidemann nr. 2 Code. 1393

Heidemann nr. 3 Code. 1394

CEMENT SPATULAS

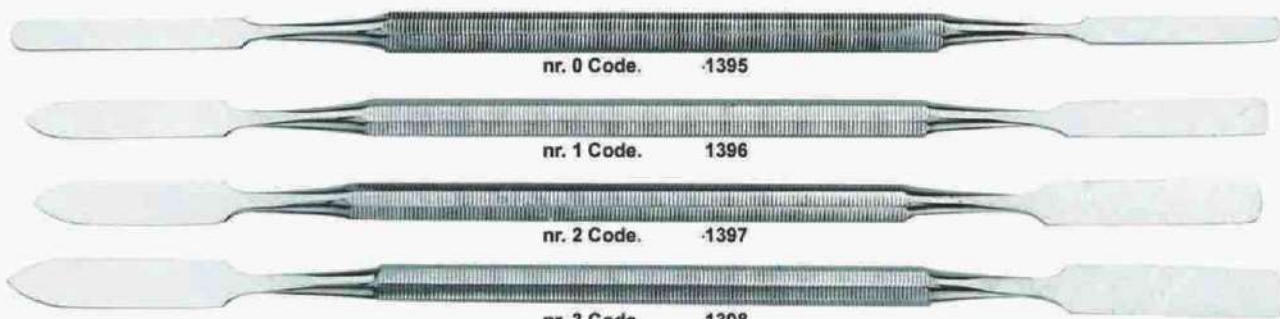

nr. 0 Code. 1395

nr. 1 Code. 1396

nr. 2 Code. 1397

nr. 3 Code. 1398

APPLICATORE



Code. 1399

PLASTIC FILLING INSTRUMENTS



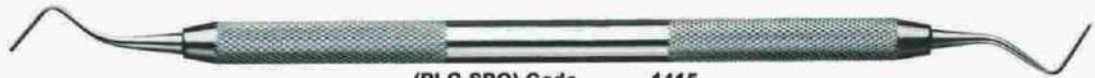

(PLG SPO) Code. 1415



Tanner nr. 0T Code. 1416

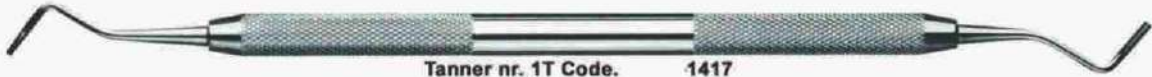

Tanner nr. 1T Code. 1417

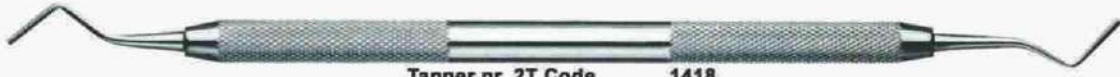

Tanner nr. 2T Code. 1418

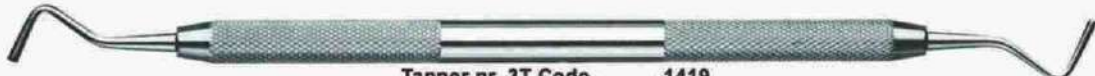

Tanner nr. 3T Code. 1419

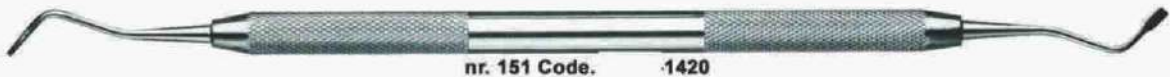

nr. 151 Code. 1420



nr. 153 Code. 1421

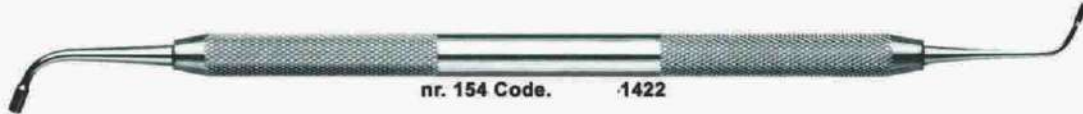

nr. 154 Code. 1422



Westcott nr. 21 Code. 1423

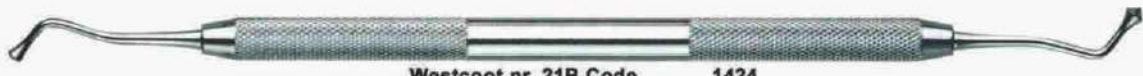

Westcott nr. 21B Code. 1424



Ball nr. 18 Code. 1425

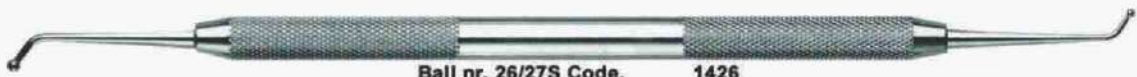

Ball nr. 26/27S Code. 1426

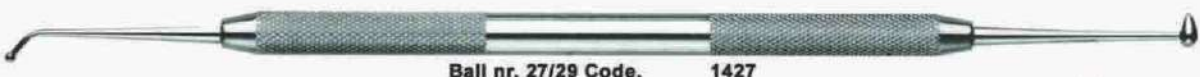

Ball nr. 27/29 Code. 1427

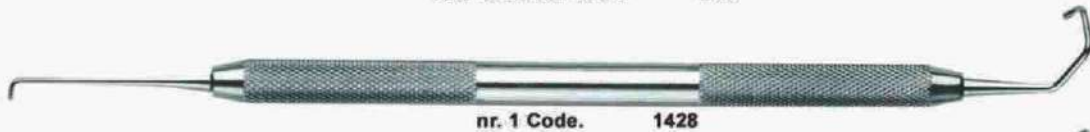

nr. 1 Code. 1428



nr. 2 Code. 1429

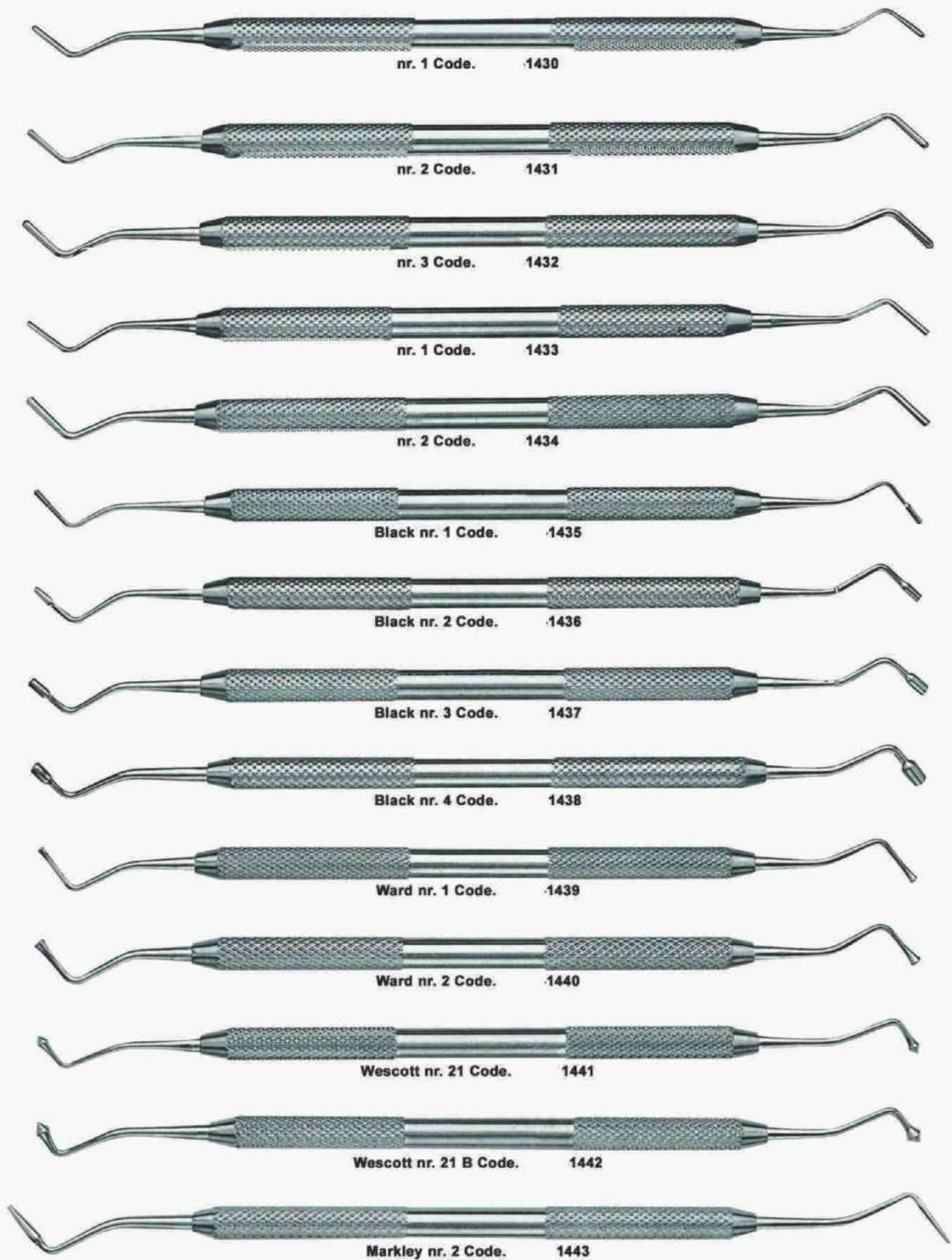

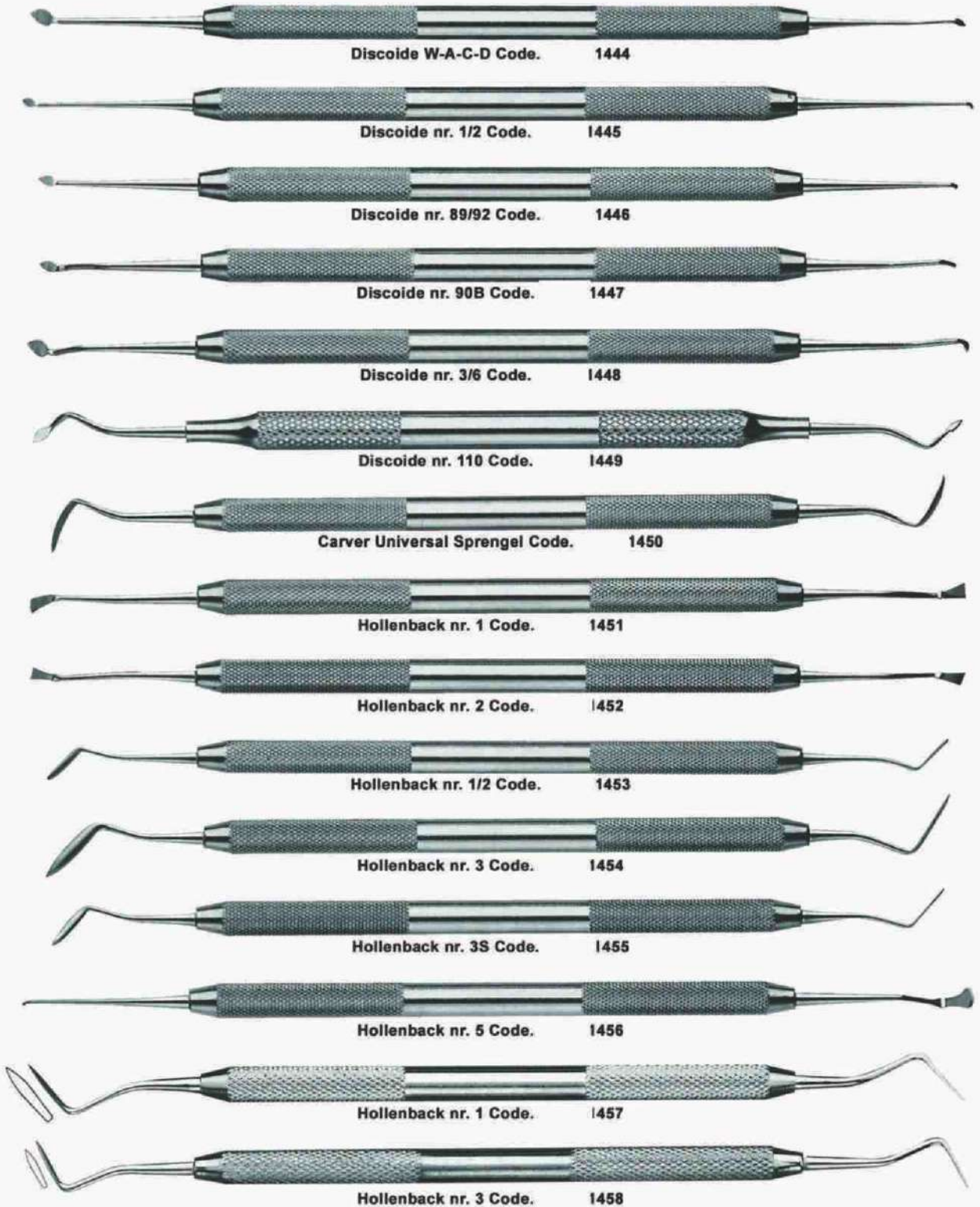



Carver Frahm nr. 2/3 Code. 1449



Carver Ward nr. 1 Code. 1450



Carver Ward nr. 1S Code. 1451

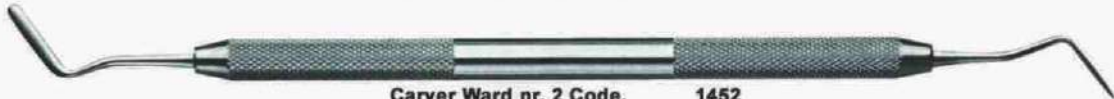

Carver Ward nr. 2 Code. 1452



Carver Tanner nr. 3 Code. 1453



Carver Tanner nr. 4 Code. 1454



Carver Tanner nr. 5 Code. 1455

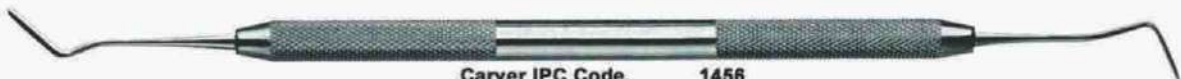

Carver IPC Code. 1456



Carver IPC off-Angel Code. 1457



Carver Andrews nr. 1 Code. 1458



Carver nr. 104 Code. 1459

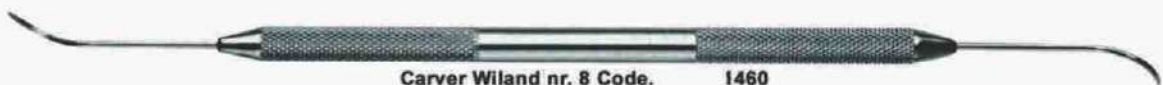

Carver Wiland nr. 8 Code. 1460



Carver (Cr 20) Code. 1461



Carver compsit Code. 1462

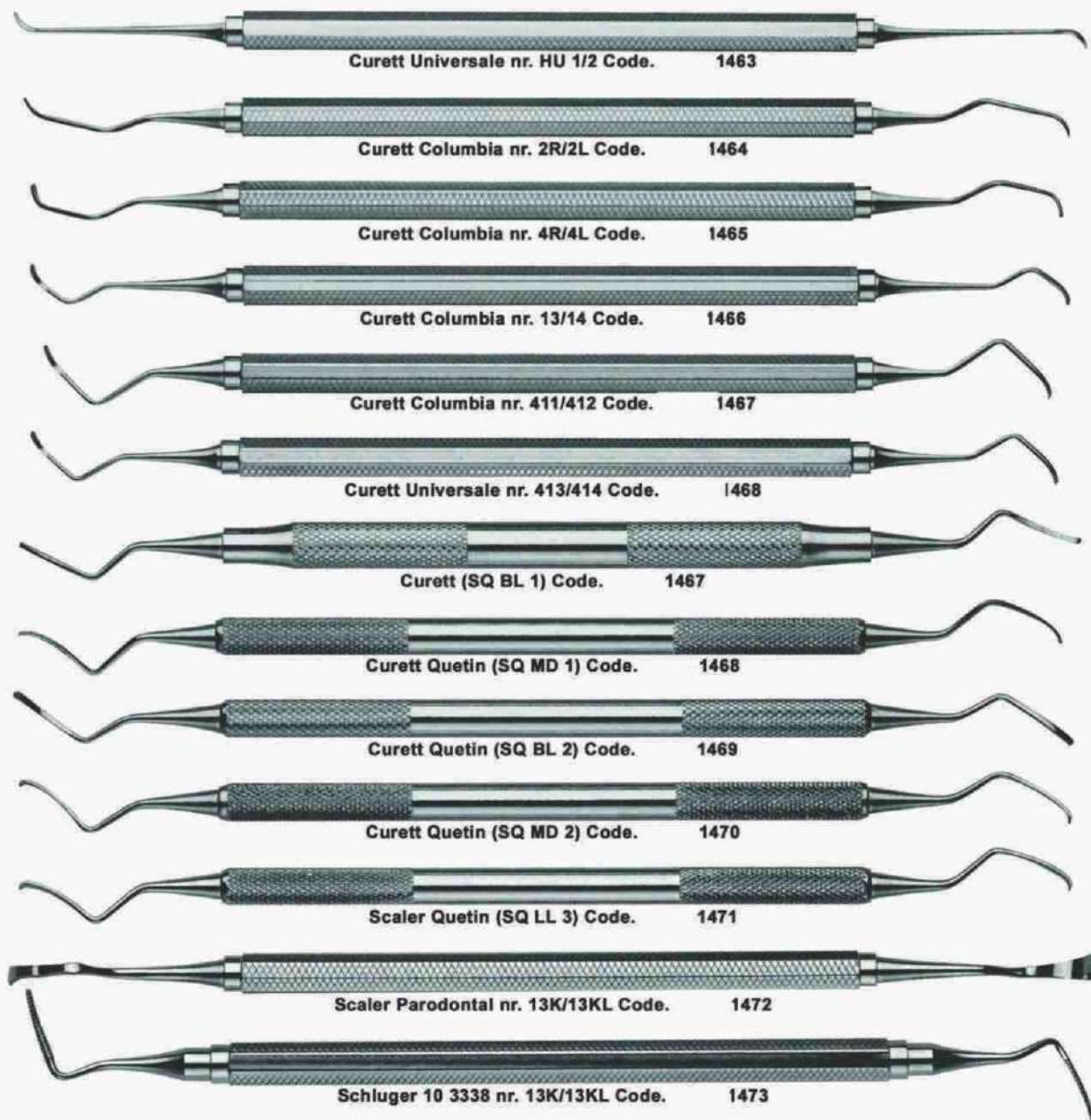

FILLING INSTRUMENTS

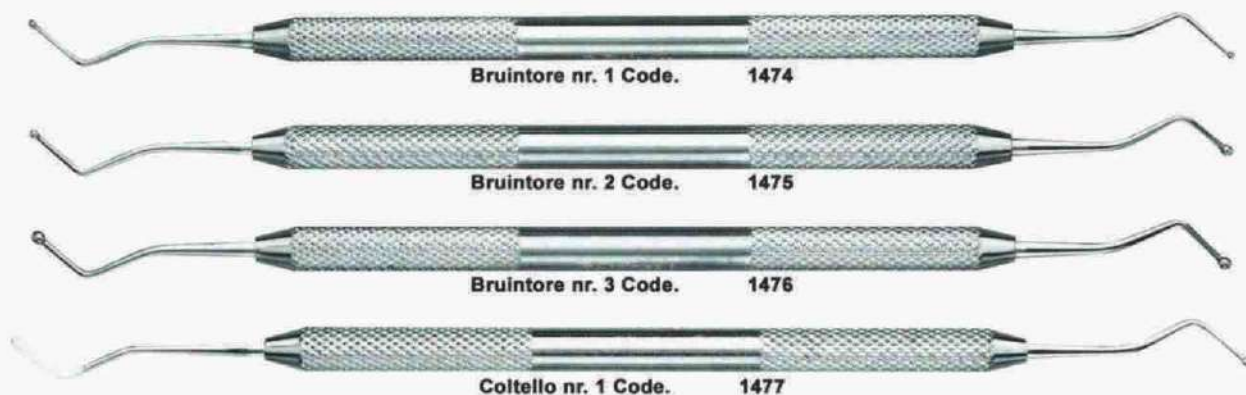



Coltello nr. 15K/16K Code. 1478



Coltello Golman-Fox nr. 7 Code. 1479



Coltello Golman-Fox nr. 8 Code. 1480

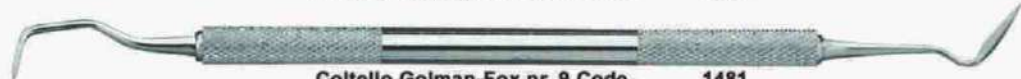

Coltello Golman-Fox nr. 9 Code. 1481

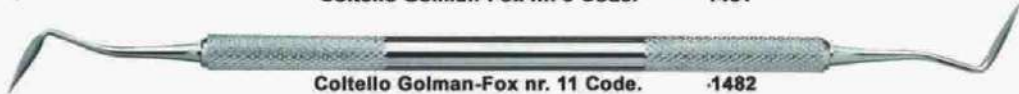

Coltello Golman-Fox nr. 11 Code. 1482



Prichard nr. PR-3 Code. 1483



Molt nr. 9 Code. 1484



Howard nr. 9H Code. 1485



Freer nr. 15 Code. 1486



Freer nr. 16 Code. 1487



Hopkins nr. 1 Code. 1488



Hopkins nr. 2 Code. 1489

PLASTIC FILLING INSTRUMENTS



Brunitore nr. 2 Code. 1490

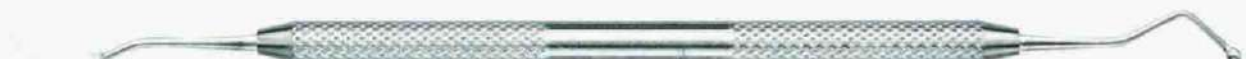

Brunitore nr. 3 Code. 1491



Brunitore nr. 1 Code. 1492



Brunitore nr. 2 Code. 1493



Brunitore nr. 3 Code. 1494



Escavatore nr. 6 Code. 1495



Escavatore nr. 14 Code. 1496



Escavatore nr. 17 Code. 1497



Escavatore nr. 17 W Code. 1498



Escavatore nr. 18 Code. 1499



Escavatore nr. 18 W Code. 1500



Escavatore nr. 19 Code. 1501



Escavatore nr. 19 W code. 1502



Escavatore nr. 39 Code. 1503



Escavatore nr. 63/64 Code. 1504



Escavatore nr. 65/66 Code. 1505



Escavatore nr. 100 Code. 1506



Excavatore nr. 101 Code. 1507



Excavatore nr. 102 Code. 1508



Excavatore nr. 103 Code. 1509



Excavatore nr. 104 Code. 1510



Excavatore nr. 111 Code. 1511



Excavatore nr. 112 Code. 1512



Excavatore endodontico nr. 31 L Code. 1513



Excavatore endodontico nr. 32 L Code. 1514



Excavatore endodontico nr. 33 L Code. 1515



Spatola nr. 1 Code. 1516



Spatola nr. 2 Code. 1517



Spatola nr. 3 Code. 1518



Black nr. 26 Code. 1519



Black nr. 27 Code. 1520



Black nr. 28 Code. 1521



Black nr. 29 Code. 1522



Black nr. 77/78 Code. 1523



Black nr. 79/80 Code. 1524



Black nr. 51/52 Code. 1525



Black nr. 53/54 Code. 1526



Wedelstadt nr. 22/23 Code. 1527



Wedelstaedt nr. 24/25 Code. 1528



Wedelstaedt nr. 26/27 Code. 1529

APPLICATORE

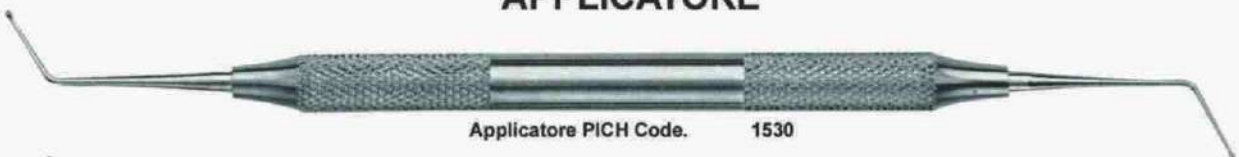

Applicatore PICH Code. 1530



Applicatore PICH 102 Code. 1531



Tanner nr. 0 T Code. 1532



Tanner nr. 1 T Code. 1533



Tanner nr. 2 T Code. 1534



Tanner nr. 3 T Code. 1535



Hollenback nr. H 1 Code. 1536



Hollenback nr. H 2 Code. 1537



Hollenback nr. H 3 Code. 1538



Hollenback nr. H 4 Code. 1539



Ward nr. 1 Code. 1540



Ward nr. 2 Code. 1541



Tonda nr. 1 Code. 1542



Tonda nr. 2 Code. 1543



Tonda nr. 3 Code. 1544



liscio nr. 1 L Code. 1546



liscio nr. 2L Code. 1547



liscio nr. 3 L Code. 1548



Zigrinato nr. 1 Code. 1549



Zigrinato nr. 2 Code. 1549



Zigrinato nr. 3 Code. 1550



Black nr. 1 Code. 1551



Black nr. 2 Code. 1552



Black nr. 3 Code. 1553



Black nr. 4 Code. 1554



Black nr. 1 Code. 1555



Black nr. 2 Code. 1556



Black nr. 3 Code. 1557



Black nr. 4 Code. 1558



CARVERS



Cleide-Discoide nr. 89/92 Code. 1572



Cleide-Discoide nr. 1/2 Code. 1573



Cleide-Discoide nr. 3/6 Code. 1574



Cleide-Discoide W-A-C-D Code. 1575



Frahm nr.2/3 Code. 1576



Carver Hollenback nr. 1/2 Code. 1577



Carver Hollenback nr. 1/2 - 3 Code. 1578



Carver Hollenback nr. 3 Code. 1579



Carver Hollenback nr. 3 S Code. 1580



Carver Ward nr. 1 Code. 1581



Carver Ward nr. 1 S Code. 1582



Carver Ward nr. 2 Code. 1583



Carver nr. 104 Code. 1584



Carver IPC Code. 1585



Carver IPC Off-Angle Code. 1586



Carver Wiland 8 (IPC) Code. 1587



Modellatore USC/2 Code. 1588



Heidemann nr. 1 Code. 1589



Heidemann nr. 2 Code. 1590



Heidemann nr. 3 Code. 1591



Coltello nr. 1 Code. 1592



Coltello nr. 2 Code. 1593



Coltello nr. 3 Code. 1594



Gengivale Code. 1595



Curette Langer nr. 1/2 Code. 1596



Curette Langer nr. 3/4 Code. 1597



Curette Columbia nr. 2 R/2 L Code. 1598



Curette Columbia nr. 4 R/4 L Code. 1599



Curette Columbia nr. 13/14 Code. 1600



Curette Columbia nr. HU 1/2 Code. 1601



Curette Columbia nr. 411/412 Code. 1602



Curette Columbia nr. 413/414 Code. 1603



Scaler taylor nr. T 2/3 Code. 1604



Scaler nr. 204 Code. 1605



Scaler nr. 204 S Code. 1606



Scaler CI-2/3 Code. 1607



Scaler Crane-Kaplan CK 6 Code. 1608

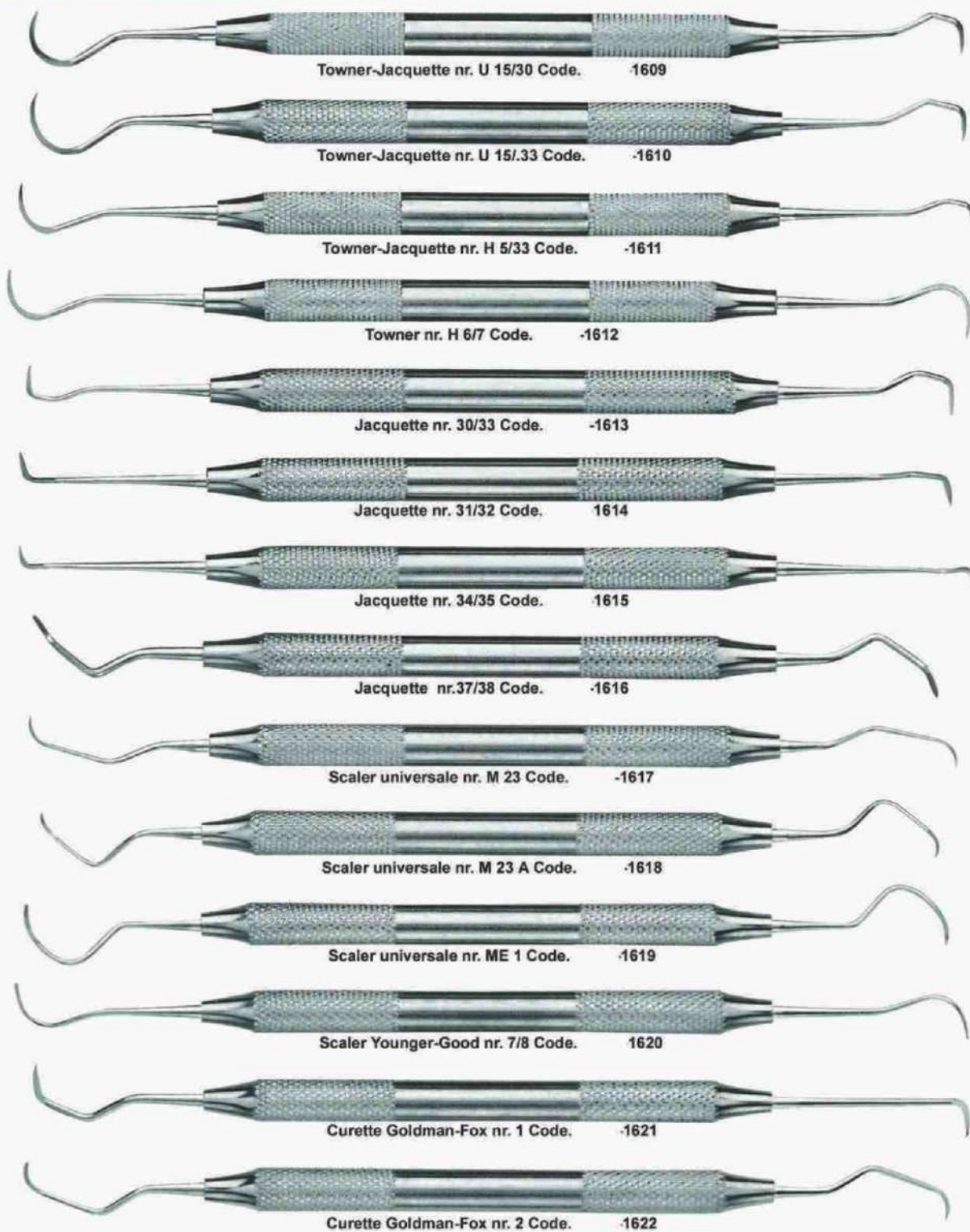

SCALER & CURETTES



SCL H6/H7
Code. 1625

SCL 204-S
Code. 1626



Curette Goldman-Fox nr. 3 Code. 1627



Curette Goldman-Fox nr. 4 Code. 1628



Coltello Goldman-Fox nr. 7 Code. 1629



Coltello Goldman-Fox nr. 8 Code. 1630



Coltello Goldman-Fox nr. 9 Code. 1631



Coltello Goldman-Fox nr. 21 Code. 1632



Coltello Kirkland nr. K 15/16 Code. 1633



Coltello Orban nr. 1/2 Code. 1634



Coltello Towner nr. 19/20 Code. 1635



Coltello Crane-Kaplan CK 3 Code. 1636



Coltello Buck nr. 3/4 Code. 1637



Coltello Buck nr. 5/6 Code. 1638



HHopkins nr. 1 Code. 1639



Hopkins nr. 2 Code. 1640



Mead nr. 3 Code. 1641



Prichard nr. PR-3 Code. 1642



Molt nr. 9 Code. 1643



Freer nr. 15 Code. 1644



Freer nr. 16 Code. 1645



Ochsenbein nr. 1 Code. 1646



Ochsenbein nr. 2 Code. 1647



Ochsenbein nr. 3 Code. 1648

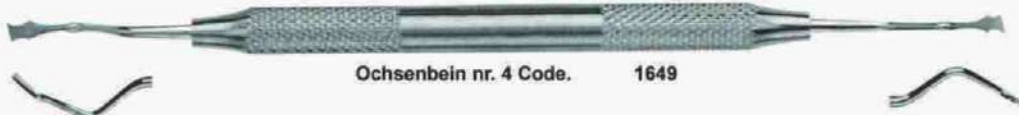

Ochsenbein nr. 4 Code. 1649

CURETTES

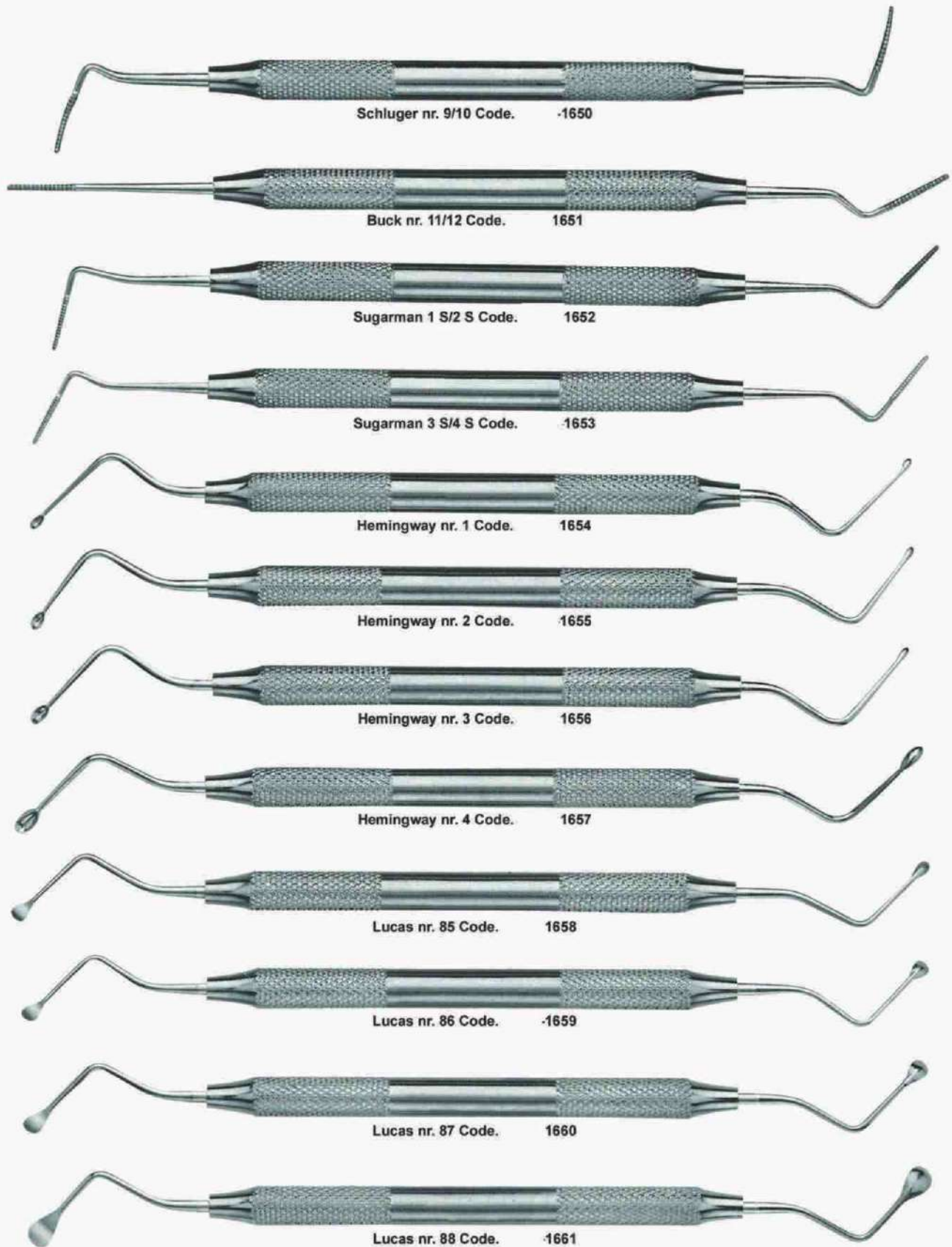



JAC nr. H5/33 Code. 1662

JAC nr. H6/H7 Code. 1663

SCL Taylor nr. T2/T3 Code. 1664

SCL nr. 204 Code. 1665

SCL nr. 204S Code. 1666

SCL Universal nr. 204SD Code. 1667

SCL nr. 6 (SCK 6) Code. 1668

SCL nr. U15/30 Code. 1669

SCL nr. U15/33 Code. 1670

SCL Good YG nr. 7/8 Code. 1671

SCL nr. U15 Code. 1672

SCL nr. Taylor T-1 Code. 1673

SCL nr. JAQ 3 Code. 1674

SCL nr. JAQ 2 Code. 1675

SCL nr. JAQ 1 Code. 1676



EXCAVATORS

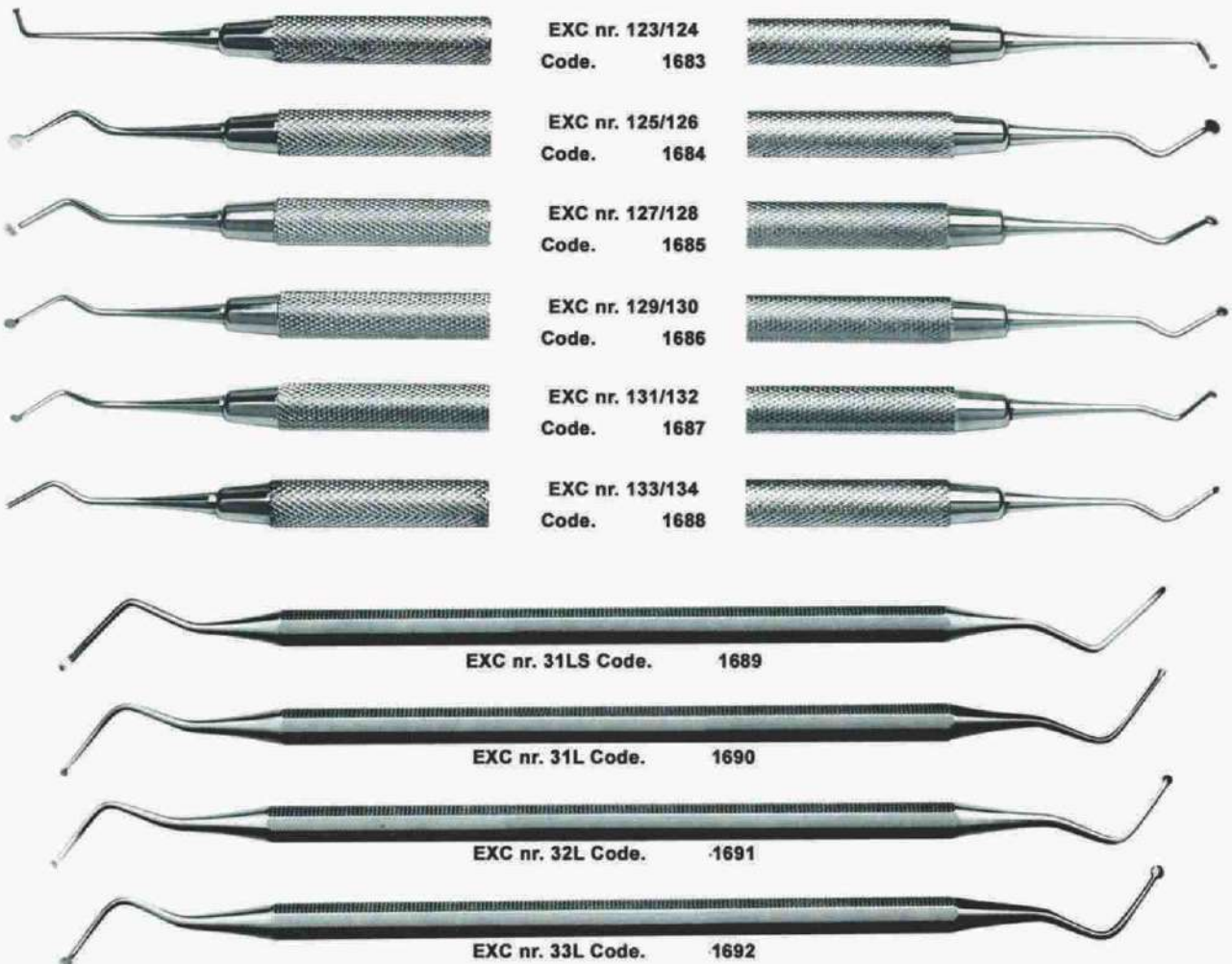

- | | | |
|--|-----------------------|------|
|  | EXC nr. 72/73 Code. | 1693 |
|  | EXC nr. 73/74 Code. | 1694 |
|  | EXC nr. 113/114 Code. | 1695 |
|  | EXC nr. 115/116 Code. | 1696 |
|  | EXC nr. 117/118 Code. | 1697 |
|  | EXC nr. 119/120 Code. | 1698 |
|  | EXC nr. 121/122 Code. | 1699 |
|  | EXC nr. 123/124 Code. | 1700 |
|  | EXC nr. 125/126 Code. | 1701 |
|  | EXC nr. 127/128 Code. | 1702 |
|  | EXC nr. 129/130 Code. | 1703 |
|  | EXC nr. 131/132 Code. | 1704 |
|  | EXC nr. 133/134 Code. | 1705 |
|  | EXC nr. 135/136 Code. | 1706 |
|  | EXC nr. 153/154 Code. | 1707 |
|  | EXC nr. 155/156 Code. | 1708 |



EXC nr. 157/158 Code. 1709



EXC nr. 159/160 Code. 1710



EXC nr. 210/211 Code. 1711



EXC nr. 212/213 Code. 1712



EXC nr. 214/215 Code. 1713



EXC nr. 220/221 Code. 1714



EXC nr. 243 Code. 1715



EXC nr. 244 Code. 1716



EXC nr. 245 Code. 1717



EXC nr. 246 Code. 1718



Guy's nr. 1 Code. 1719



Guy's nr. 2 Code. 1720



Guy's nr. 3 Code. 1721



Guy's nr. 4 Code. 1722



Guy's nr. 5 Code. 1723



Guy's nr. 6 Code. 1724

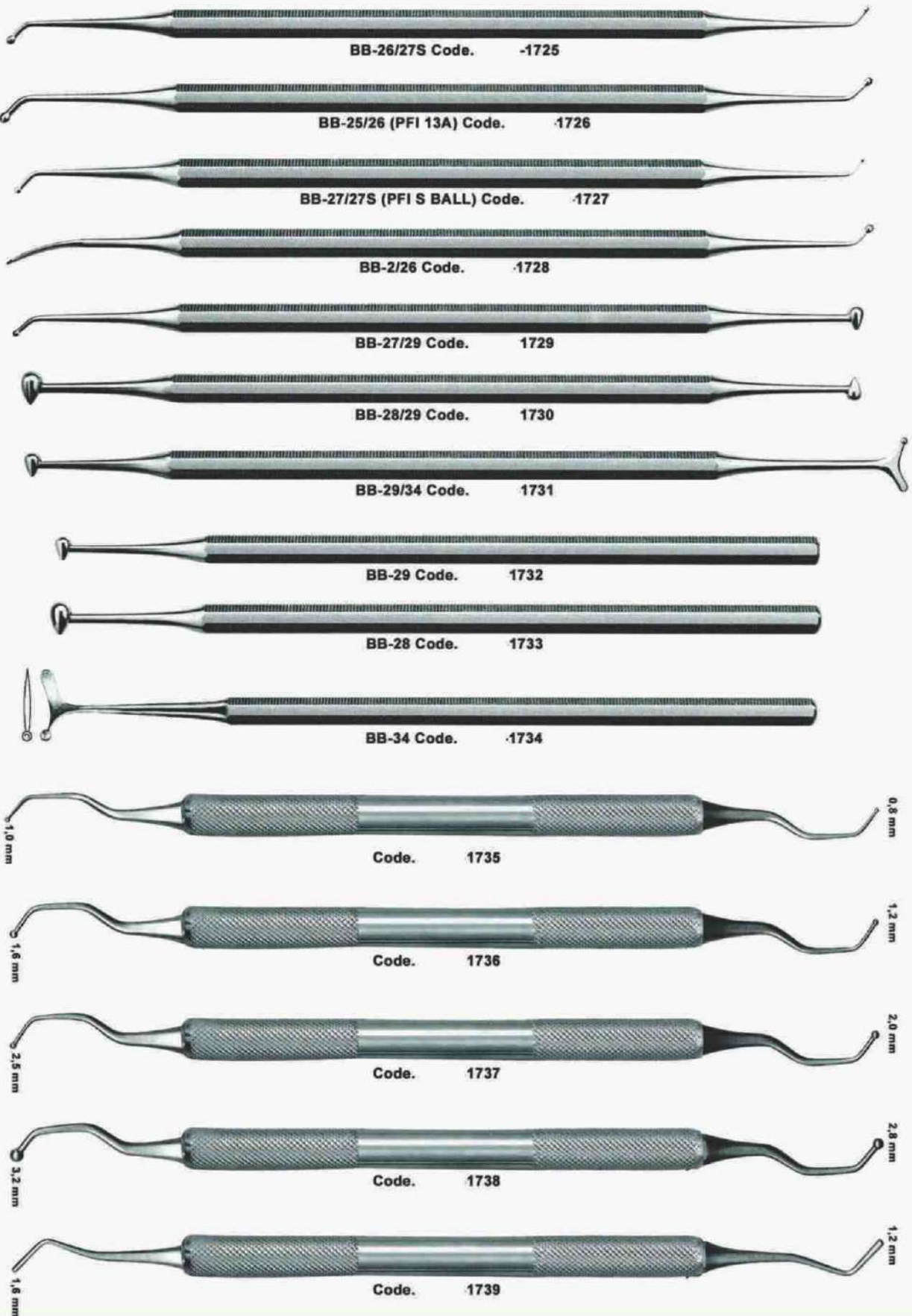

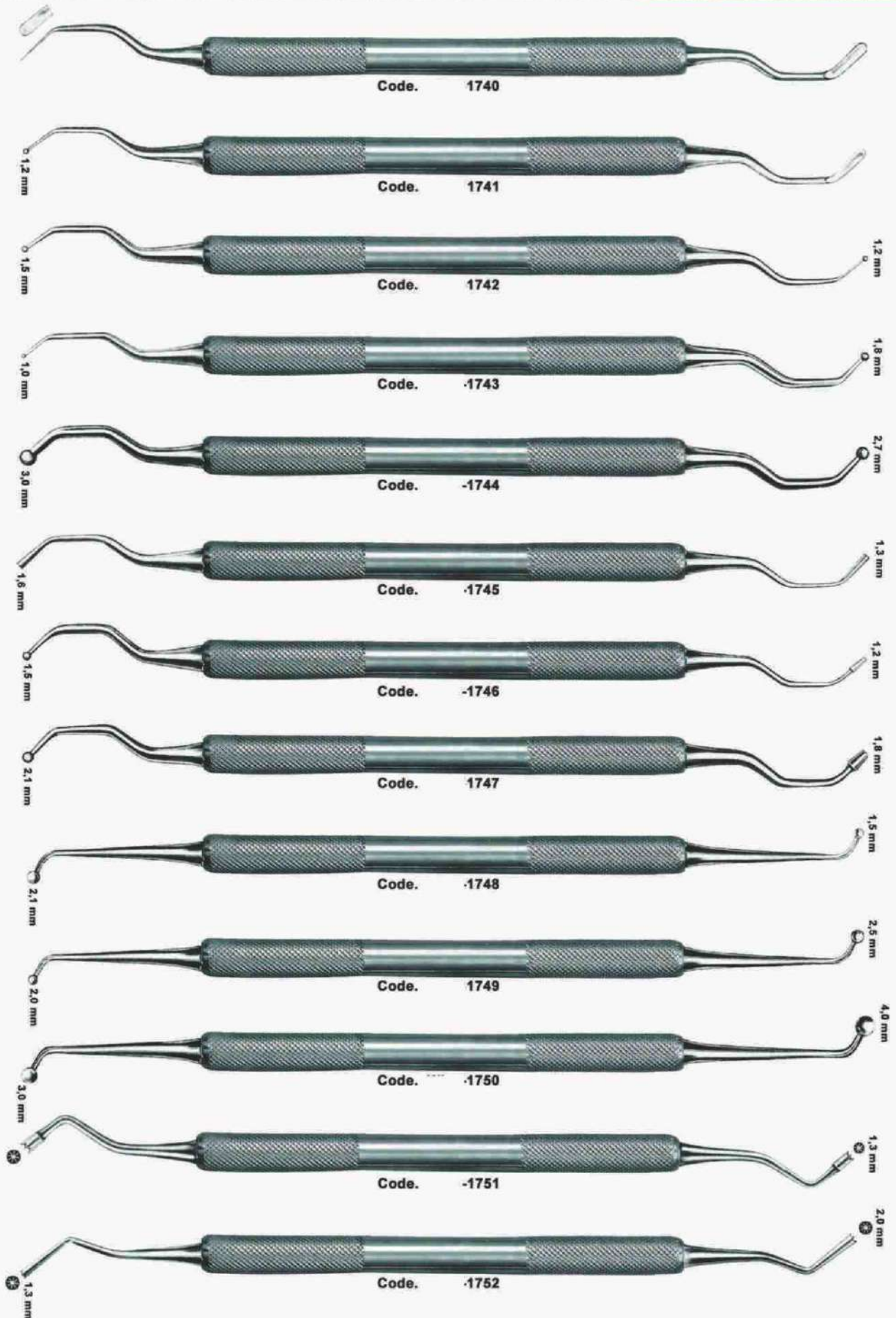



W1 Code. 1753



W3 Code. 1754

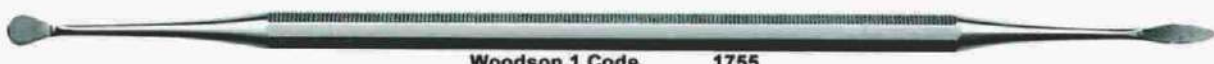

Woodson 1 Code. 1755



Woodson 2 Code. 1756



Woodson 3 Code. 1757



Trico 1/2 Code. 1758



S1 Code. 1759



S6 Code. 1760



11 Code. 1761



Riegner Code. 1762



Beale Code. 1763



Roach Code. 1764

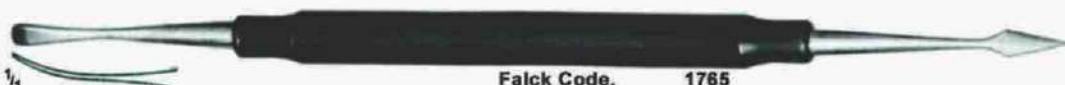

Falck Code. 1765



MOLT 9 Code. 1766



PPR 3 Code. 1767

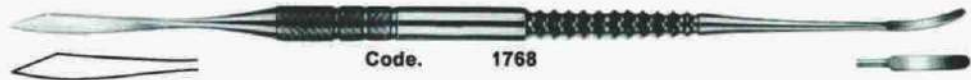

Code. 1768

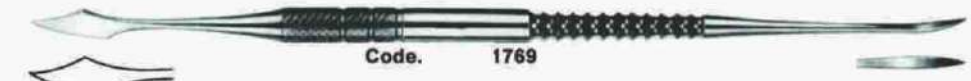

Code. 1769



Code. 1770



Code. 1771



Code. 1772



ZAHLE Code. 1773

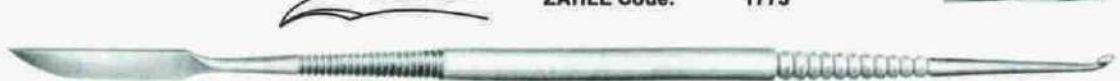

LECRON Code. 1774

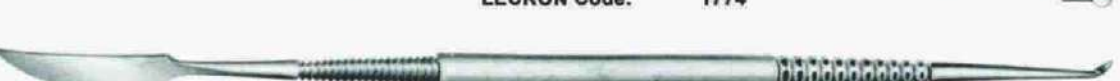

LECRON Code. 1775



Hylin Code. 1776

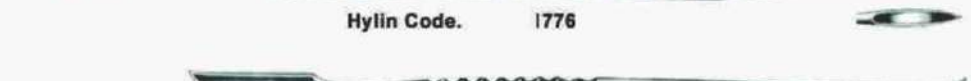

Code. 1777



Hylin Code. 1778



Code. 1779



Code. 1780



Code. 1781



Wax Carver and Spatula

Code. 1782

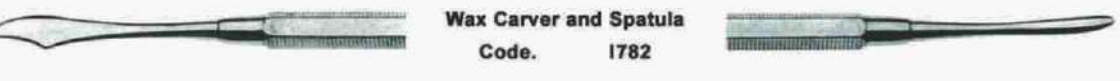

Wax 7 Code. 1783



Wax 7A Code. 1784



CVR-1 Code. 1785



CVR-3 Code. 1786

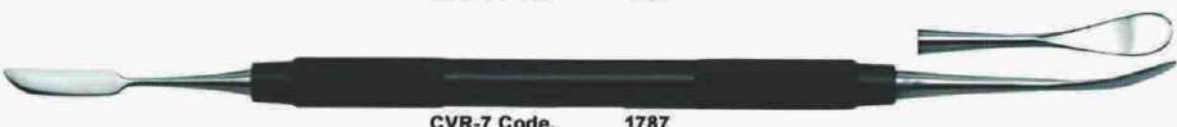

CVR-7 Code. 1787



Evince Knife No. 1 Code. 1788

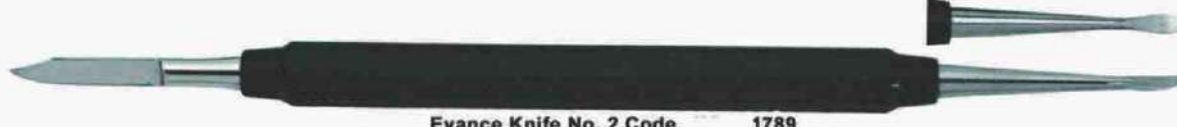

Evince Knife No. 2 Code. 1789



Carving Knife No. 11 Code. 1790



RPD Carver
RPD Abutment Crown, Rest seat Parallel Guiding Plan Ledge. Code 1791



PFM Carver
PFM Veneer Orientation groove wax Porcelain metal margin Rest seat, Ledge. Code 1792



Gritman Wax Sp Code 1793

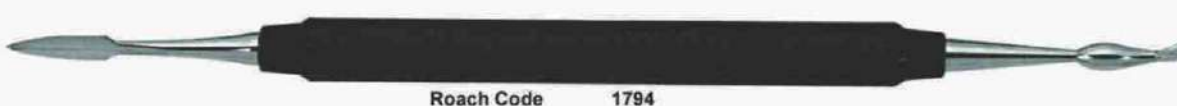

Roach Code 1794

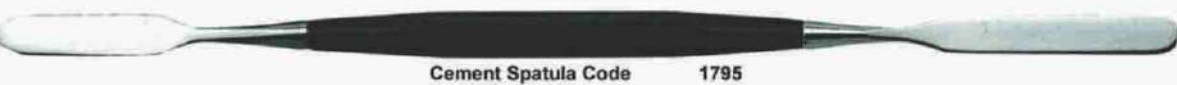

Cement Spatula Code 1795



Porcelane Spatula Code 1796

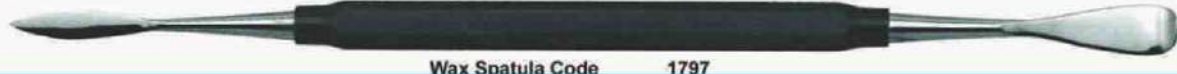

Wax Spatula Code 1797

CURETTES



ROOT TIP HEIDBRINK

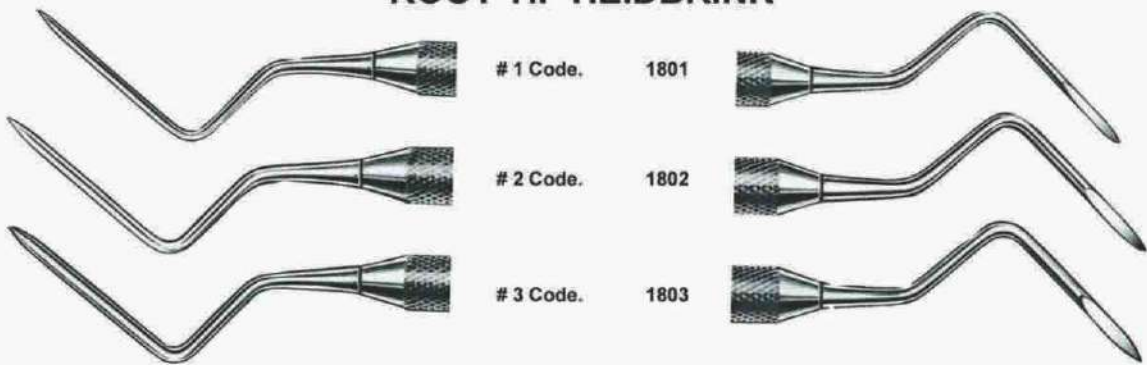

CURETTES

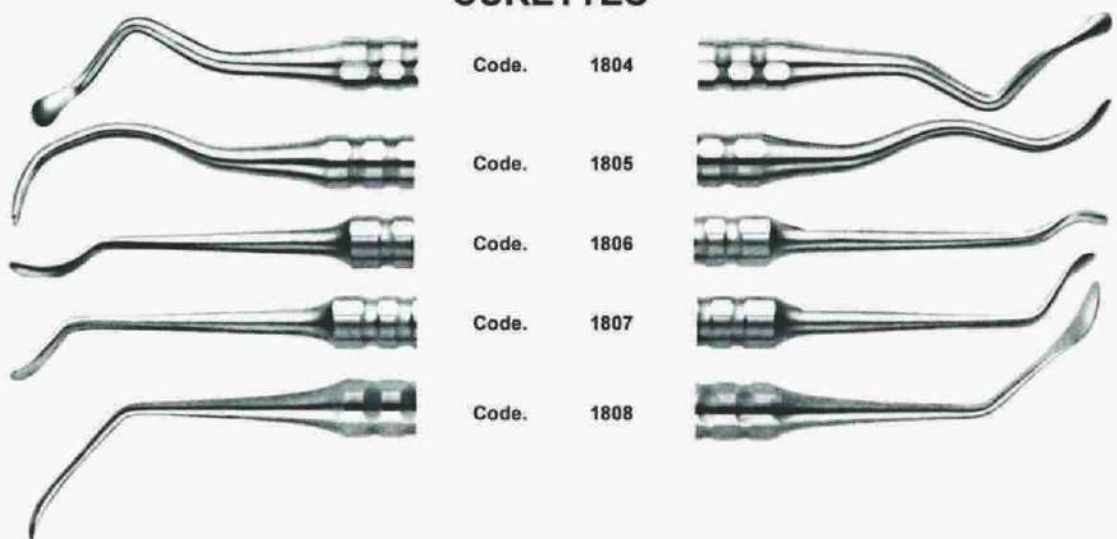

SET OF 9 No. A



COMPOSITE FILLING INSTRUMENTS SET OF 6 No. B

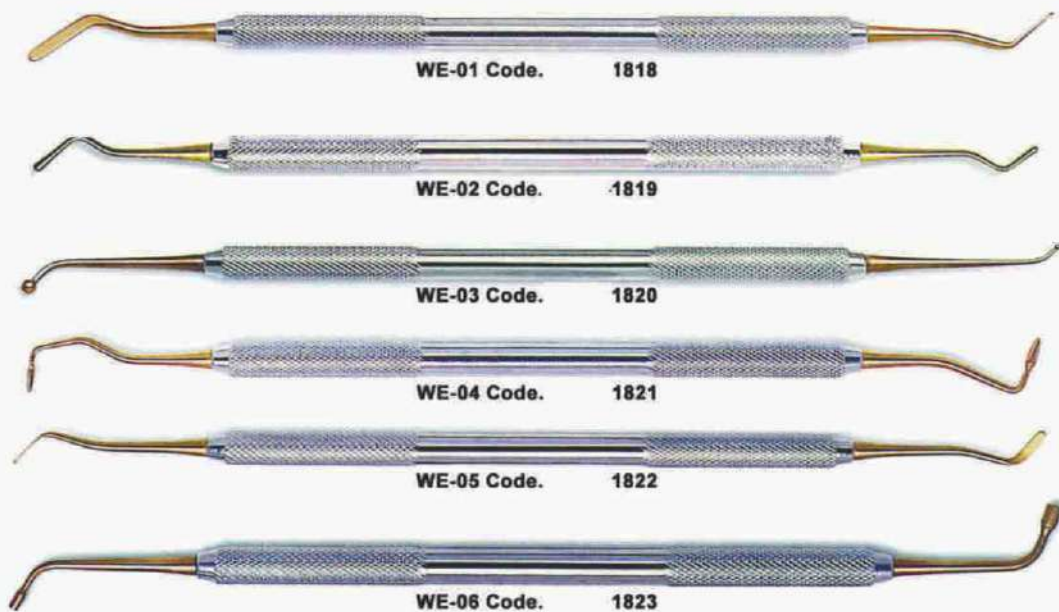

SPATULAS





SPATULAS



GRITMAN Code. 1836



Miniature Code. -1837



SP 5 Code. -1838



SP 10 Code. -1839

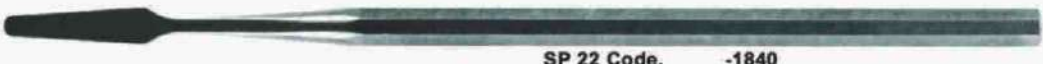

SP 22 Code. -1840



SP. 24A Code. -1841



SP. 24 Code. -1842



SP. 36 Code. -1843



SP. CMI 24 Code. -1844

CURETTES

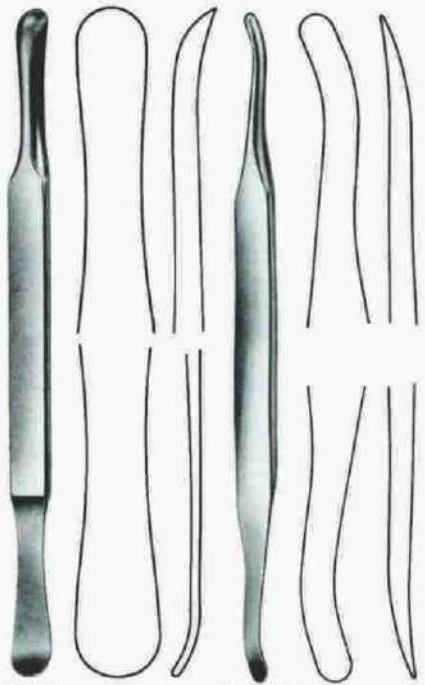

SELDIN Code. -1845

SELDIN Code. -1846

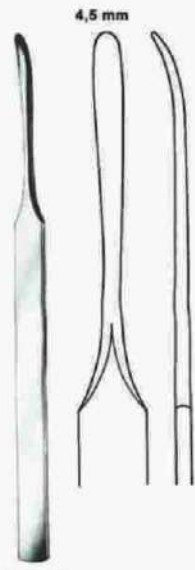

KONIG Code. -1847

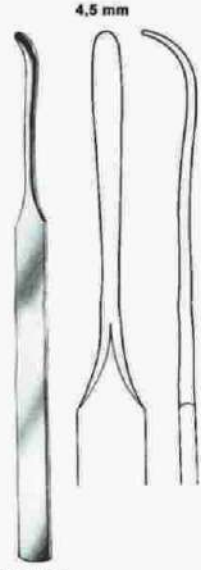

KONIG Code. -1848



FREER Code. -1849



FREER Code. -1850

BLADE HOLDERS

SICOP
Surgical Instruments
Co. of Pak



Code. 1851



Code. 1852



No. 3 Code. 1853



No. 4 Code. 1854



Code. 1855



Code. 1856



No. 7 Code. 1857



Straight 1858 CVD Code. 1859



Code. 1860



Code. 1861

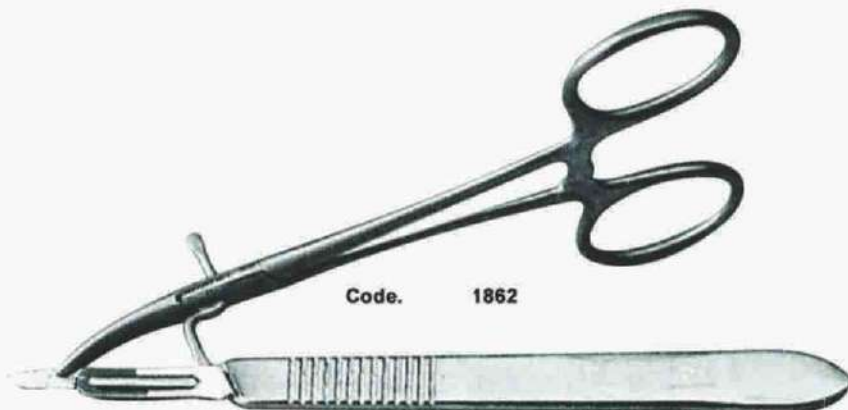

Code. 1862



Code. 1863



Code. 1864



Code. 1865



Code. 1866



Code. 1867



Code. 1868



Code. 1869



Code. 1870



Code. 1871

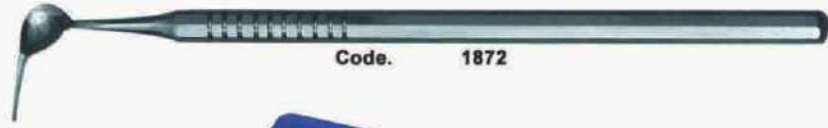

Code. 1872



Complete Set. Code. 1873

MOUTH MIRRORS & HANDLES

#3 20mm #4 22mm #5 24mm



CS Mirror

PLANE	
#3 Code.	1876
#4 Code.	1877
#5 Code.	1878

MAGNIFYING	
#3 Code.	-1882
#4 Code.	-1883
#5 Code.	-1884

FRONT SURFACE	
#3 Code.	1889
#4 Code.	1890
#5 Code.	1891

#3 20mm #4 22mm #5 24mm



SS Mirror

PLANE	
#3 Code.	-1879
#4 Code.	-1880
#5 Code.	-1881

MAGNIFYING	
#3 Code.	1885
#4 Code.	1886
#5 Code.	1887

FRONT SURFACE	
#3 Code.	1892
#4 Code.	1893
#5 Code.	1894



SS Type

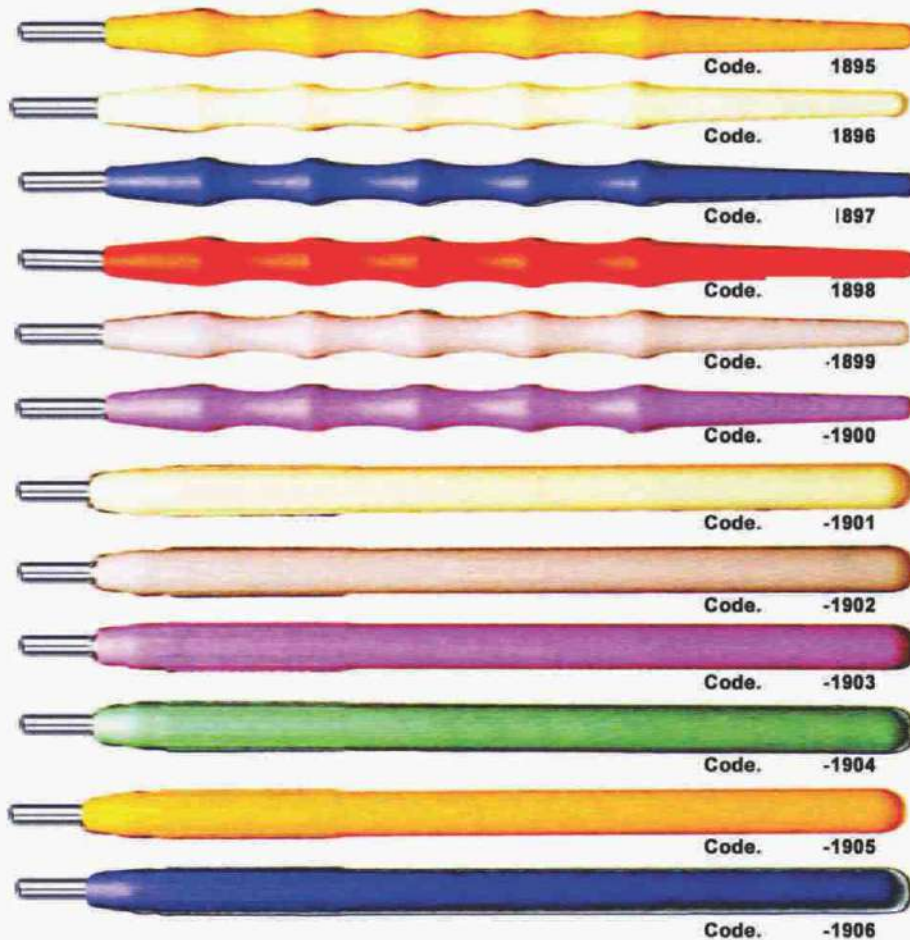

Code. 1895

Code. 1896

Code. 1897

Code. 1898

Code. -1899

Code. -1900

Code. -1901

Code. -1902

Code. -1903

Code. -1904

Code. -1905

Code. -1906



1907



1908



1909



10



Code. 1911



Code. 1912



Code. 1913

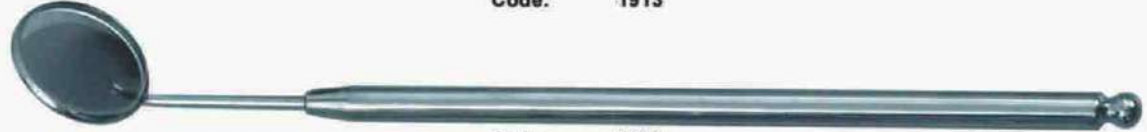

Code. 1914

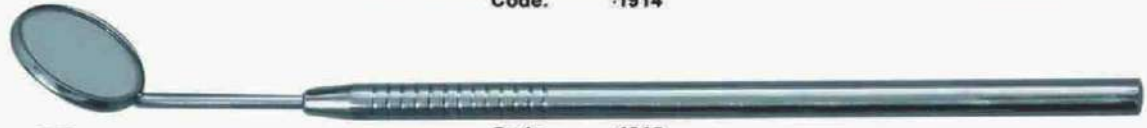

Code. 1915



Code. 1916



Code. 1917



Code. 1918



Code. 1919-Hollow



Code. 1920-Hollow



Code. 1921-Hollow



Code. 1922-Hollow



Cartridge Syringe 1.8mm 1933
Cartridge Syringe 2.2mm 1934



Cartridge Syringe 1.8mm 1935
Cartridge Syringe 2.2mm 1936



Cartridge Syringe 1.8mm 1937
Cartridge Syringe 2.2mm 1938



Cartridge Syringe 1.8mm 1939
Cartridge Syringe 2.2mm 1940

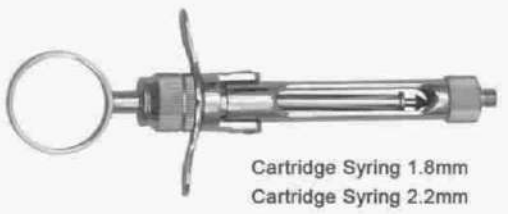

Cartridge Syringe 1.8mm 1941
Cartridge Syringe 2.2mm 1942



Pressure Syringe 1.8mm
1943



Aspirating Syringe 1.8mm 1944
Aspirating Syringe 2.2mm 1945



Skypject Syringe 110mm 1946



Aspirating Syringe
1.8mm 1947
Aspirating Syringe
2.2mm 1948

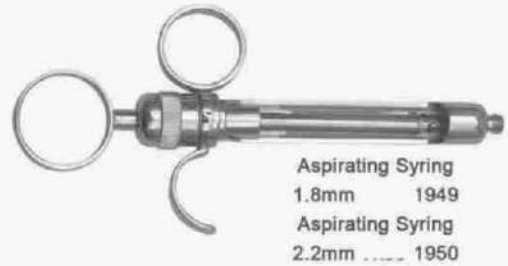

Aspirating Syringe
1.8mm 1949
Aspirating Syringe
2.2mm 1950

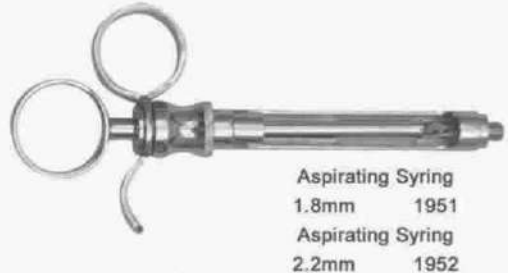

Aspirating Syringe
1.8mm 1951
Aspirating Syringe
2.2mm 1952

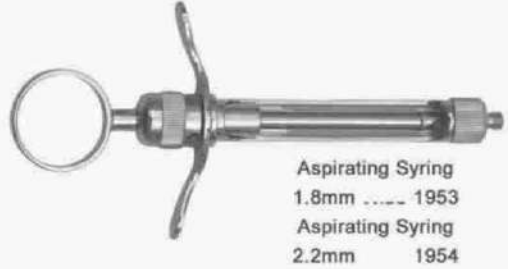

Aspirating Syringe
1.8mm 1953
Aspirating Syringe
2.2mm 1954



Aspirating Syringe
1.8mm 1955
Aspirating Syringe
2.2mm 1956

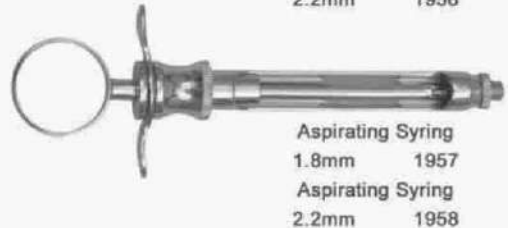

Aspirating Syringe
1.8mm 1957
Aspirating Syringe
2.2mm 1958

SYRINGES & AMALGUM GUNS



AMALGAM CARRIERS & WELLS

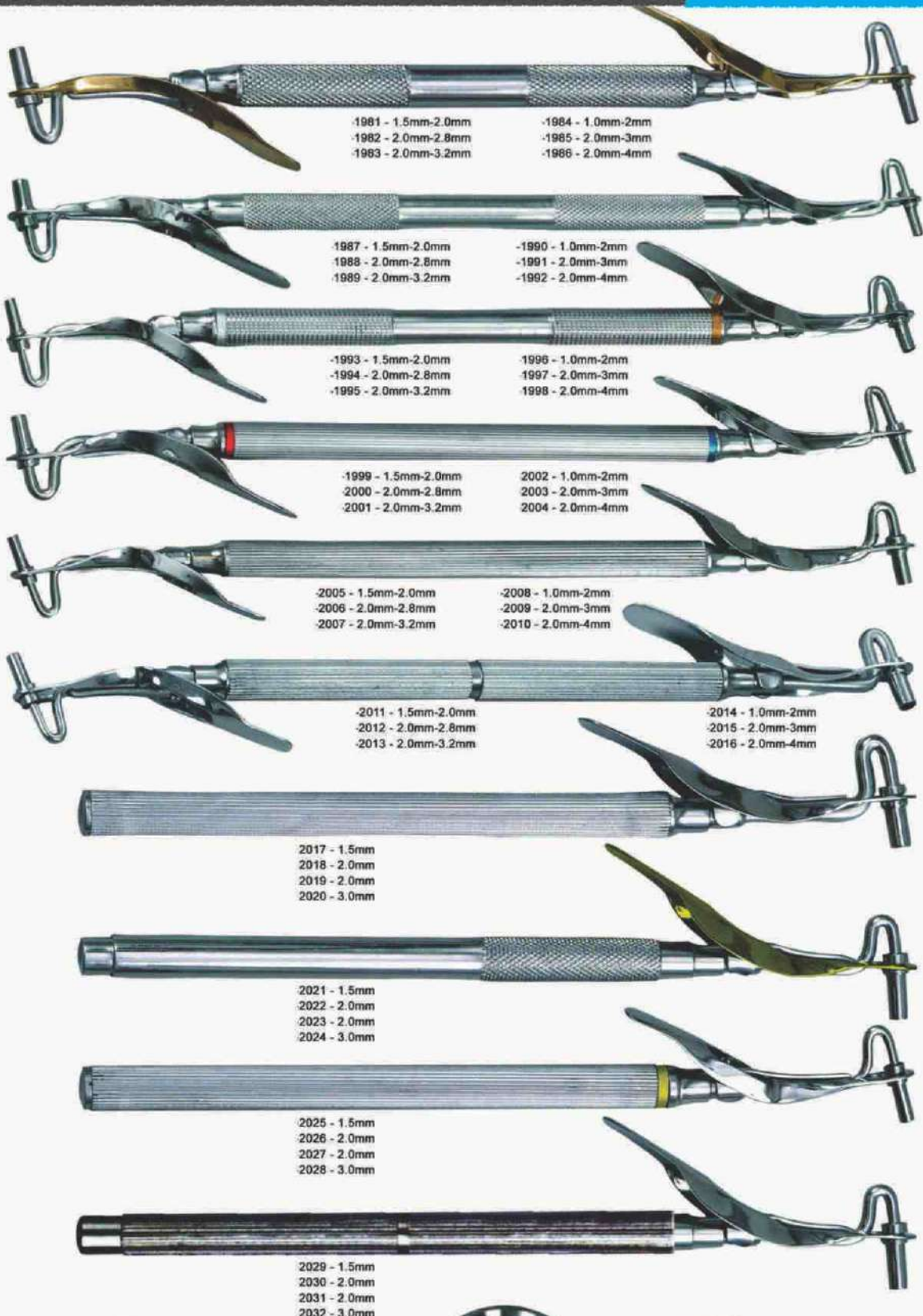

2033



2034



2035



2036



SUCTION CANNULAS & TUBES





Fig. 1 -2061



Fig. 1 -2062



Fig. 10 -2063



Fig. 10 H -2064



Fig. 10 S -2065



Fig. 13 -2066



Fig. 15 -2067



Fig. 16 -2068



Fig. 16-S 2069



Fig. 17 -2070



Fig. 18-L -2071



Fig. 18-R -2072



Fig. 23
-2073



Fig. 23-S
-2074



Fig. 24
-2075



Fig. 32
-2076



Fig. 32-A
-2077



Fig. 53-L
-2078



Fig. 53-R
-2079



Fig. 62
-2080



Fig. 65
-2081



Fig. 69
-2082



Fig. 85
-2083



Fig. 85-A
-2084



Fig. 88-L
-2085



Fig. 88-R
-2086



Fig. 99-C
2087



Fig. 99-A
2088



Fig. 101
2089



Fig. 103
2090



Fig. 150
2091



Fig. 150-A
2092



Fig. 150-XAS
2093



Fig. 150-S
2094



Fig. 151
2095



Fig. 151-A
2096



Fig. 151-XAS
2097



Fig. 151-S
2098



Fig. 203
2099



Fig. 210
2100



Fig. 210-S
2101



Fig. 217
2102



Fig. 222
-2103



Fig. 286
-2104



Fig. 287
2105



Fig. 400
-2106



Fig. 401
-2107



Fig. 586
2108



Fig. 588
2109

BABY EXTRACTING FORCEPS

SICOP
Surgical Instruments
Co. of Pak



Fig. 17-SK
2110



Fig. 23-SK
2111



Fig. 150-SK
-2112



Fig. 151-SK
-2113



Fig. 210 S-SK
-2114



Fig. 222-SK
2115



Fig. 1-SK
-2116



Fig. 3-SK
2117



#9 Fig. 5-SK
2118



Fig. 6-SK
2119



Fig. 7-SK
-2120



Fig. 1-SK
-2121



Fig. 2-SK
2122



Fig. 3-SK
2123



Fig. 4-SK
2124



Fig. 5-SK
2125



Fig. 6-SK
2126



Fig. 31
2127



Fig. 79 C-SK
2128



Fig. 4-SK
2129



Fig. 1
2130



Fig. 2
2131



Fig. 4
2132



Fig. 7
2133



Fig. 8
2134



Fig. 13
2135



Fig. 17
2136



Fig. 18
2137



Fig. 21
2138



Fig. 22
2139



Fig. 22 A
2140



Fig. 33
2141



Fig. 37
2142



Fig. 39
2143



Fig. 51
2144



Fig. 51 A
2145



Fig. 67
2146



Fig. 67 A
2147



Fig. 73
2148



Fig. 74
2149



Fig. 74 N
2150



Fig. 75
2151



Fig. 76
2152



Fig. 76 N
2153



Fig. 79
2154



Fig. 86
..... 2155



Fig. 86 C
-2156



Fig. 87
2157



Fig. 94
-2158



Fig. 95
2159



Fig. 123
-2160



Fig. 130
..... -2161



Fig. 138
2162

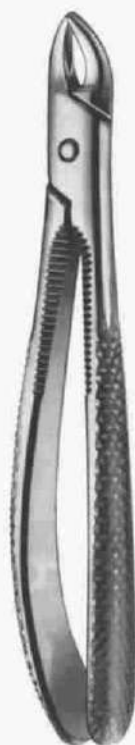

Fig. 158
-2163



Fig. 161
..... -2164



Fig. 162
2165



Fig. MD1
2166



Fig. MD 2
-2167



Fig. MD 3
-2168



Fig. MD 4
2169



Fig. 89
-2170



Fig. 90
2171



Fig. 99
-21720



Fig. 99-A
-2173



Fig. 23
-2174



Fig. 24
2175



Fig. RO 1
2176



Fig. 3
2177



Fig. 7
2178



Fig. 17
2179



Fig. 18
2180



Fig. 22
2181



Fig. 31
2182



Fig. 33
2183



Fig. 34
2184



Fig. 36
2185



Fig. 36 N
2186



Fig. 46
2187



Fig. 46 L
2188



Fig. 46 XL
2189



Fig. 49
2190



Fig. 51 A
2191



Fig. 51 B
2192



Fig. 51 XL
2193



Fig. 56
2194



Fig. 59
2195



Fig. 66 L
2196



Fig. 66 R
2197



Fig. 74
2198



Fig. 79
2199



Fig. 97 C
-2200



Fig. 80
-2201



Fig. 86 C
-2202



Fig. 97
-2203



Fig. 97 B
-2204



Fig. 107
2205



Fig. 22 1/2 L
2206



Fig. 22 1/2 R
2206



Fig. 133 L
2207



Fig. 133 R
2208



Hied Brink #1
2209



Hied Brink #2
2210



Seldin #4-S
2211



Seldin #12 M
2212



Seldin #34
2213



Seldin #34-S
2214



Seldin #40
2215



Hied Brink #41
2216



Apexo #80
2217



Apexo #81
2218



Apexo #81-E
2219



Apexo #301
2220



Apexo #302
2221



Apexo #303
2222

ROOT ELEVATORS

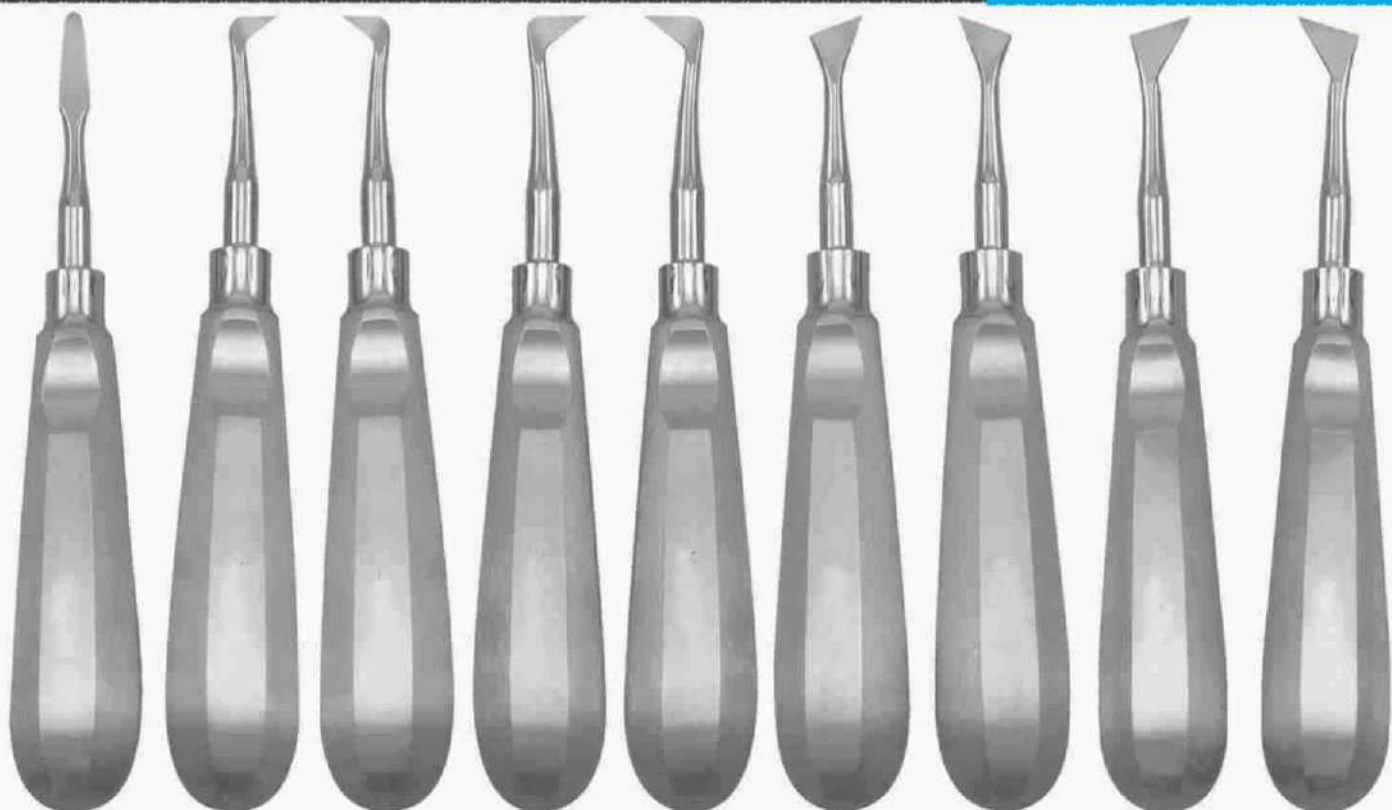

Seldin #2-S 2223 Seldin #1-L 2224 Seldin #1-R 2225 Seldin #4-L 2226 Seldin #4-L 2227 Cryer Medium #25 2228 Cryer Medium #26 2229 Cryer Large #31 2230 Cryer Large #32 2231

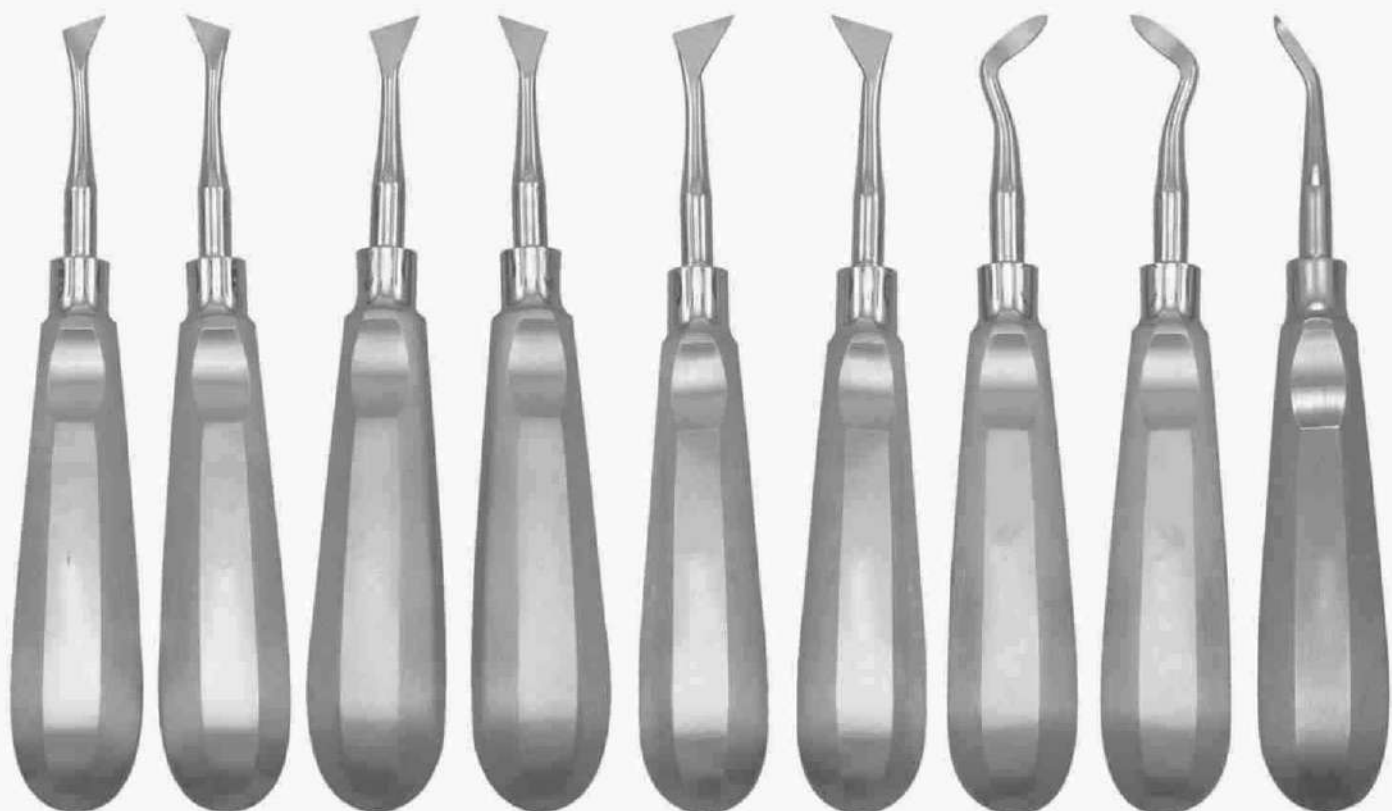

Cryer Small #30-A 2232 Cryer Small #31-A 2233 Cryer Medium #44 2234 Cryer Medium #45 2235 Cryer Large #46-L 2236 Cryer Large #46-R 2237 Barry #50 2238 Barry #51 2239 Crane Pick #8 2240

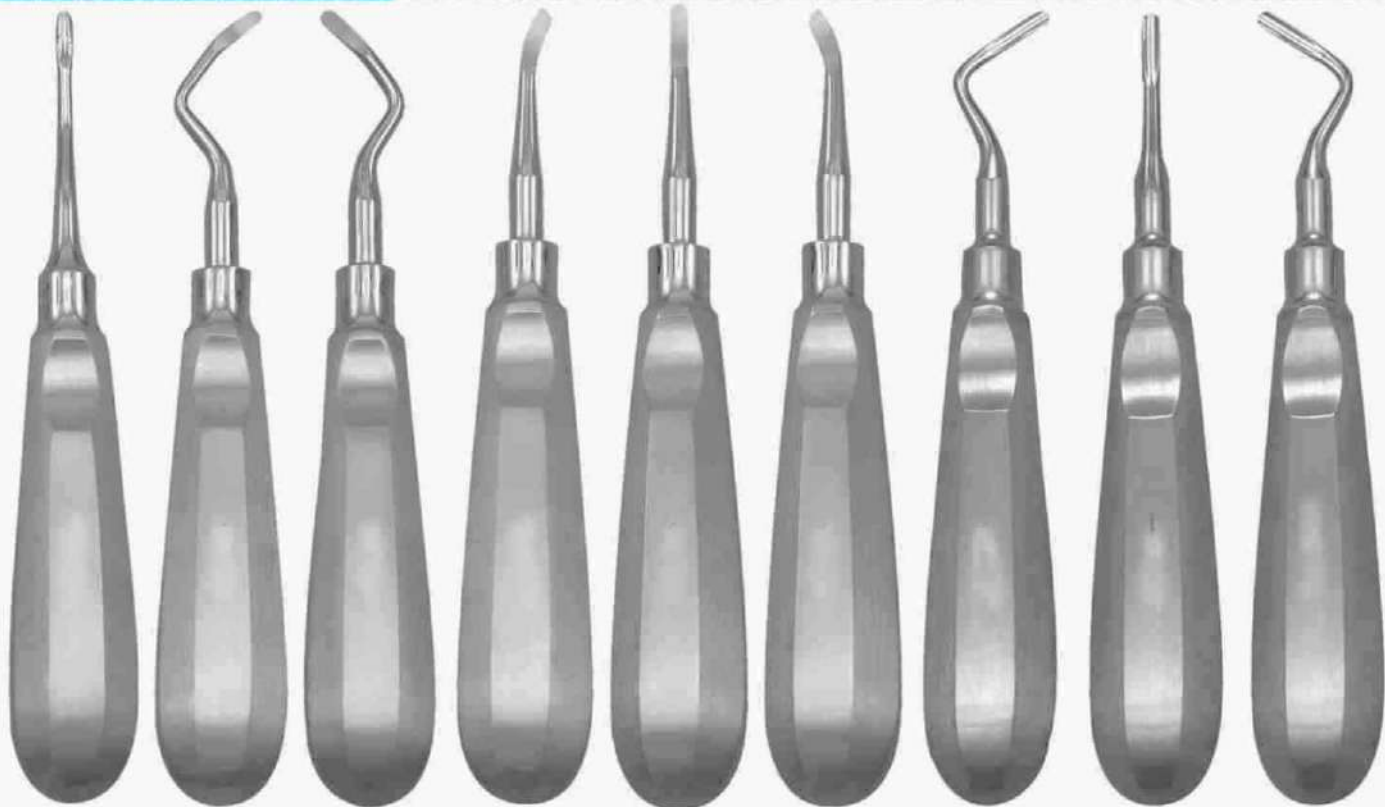

Seldin #77-R 2241	Miller Apexo #71 2242	Miller Apexo #72 2243	Miller Apexo #73 2244	Miller Apexo #70 2245	Miller Apexo #74 2246	Apical #3L / 302 2247	Apical #2S / 301 2248	Apical #4R / 303 2249
----------------------	-----------------------------	-----------------------------	-----------------------------	-----------------------------	-----------------------------	-----------------------------	-----------------------------	-----------------------------

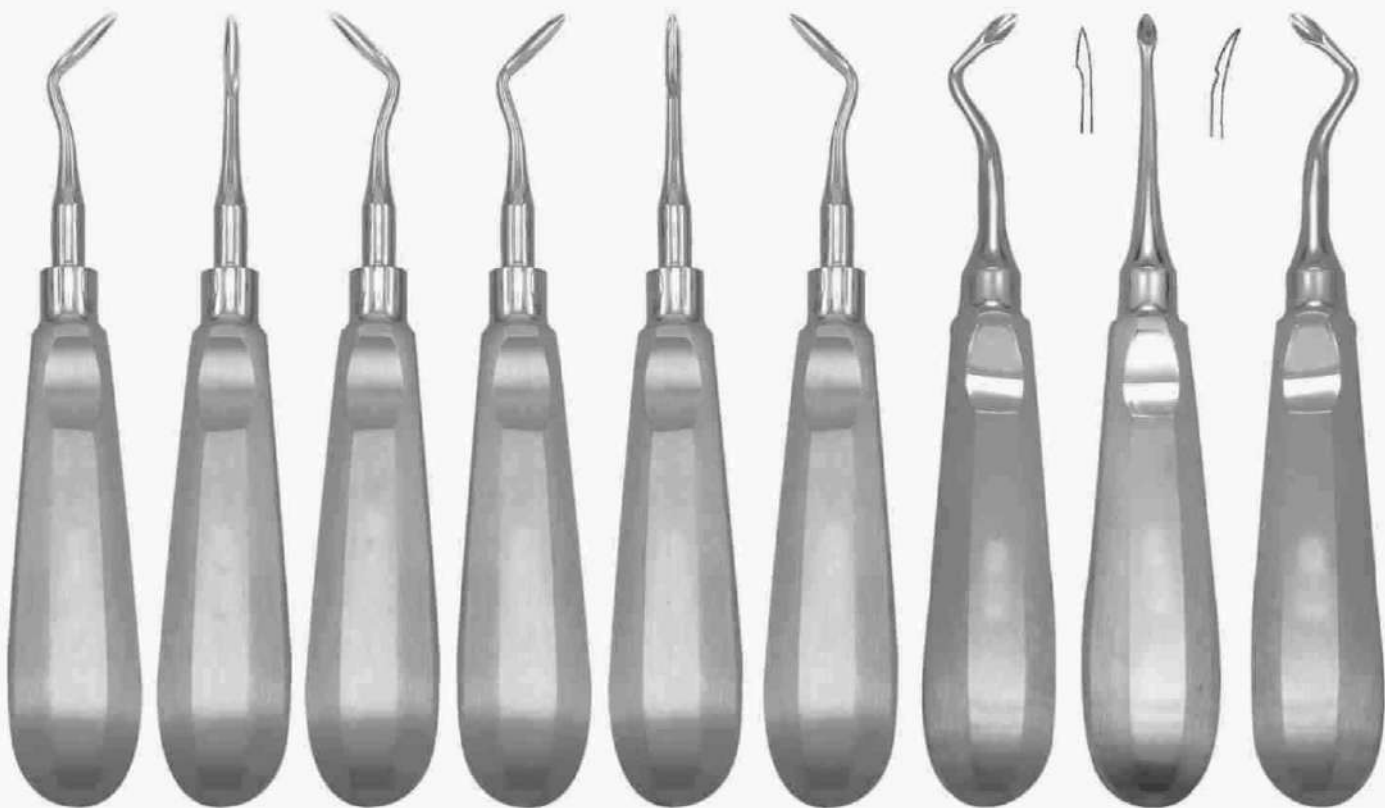

Flohr-L Blunt End 2250	Flohr-S Blunt End 2251	Flohr-R Blunt End -2252	Flohr-L Sharp End -2253	Flohr-S Sharp End 2254	Flohr-R Sharp End 2255	Burnard #3-L 2256	Burnard #2-S 2257	Burnard #4-R -2258
------------------------------	------------------------------	-------------------------------	-------------------------------	------------------------------	------------------------------	-------------------------	-------------------------	--------------------------

ROOT ELEVATORS



R.T.P. Left
2259



R.T.P. STR
2260



R.T.P. Right
2261



R.T.P. Left
2262



R.T.P. STR
2263



R.T.P. Right
2264



R.T.P. Left
2265



R.T.P. STR
2266



R.T.P. Right
2267



Molt #5
2268



Molt #0
2269



How-2
Root Tip Pick
2270



How-1
Root Tip Pick
2271



How-3
Root Tip Pick
2272



H.B #2
2273



H.B #1
2274



H.B #3
2275



H.B #5
2276



H.B #7
2277



Luxation Elevator
-2276 2mm Str
-2279 2.5m Str
-2280 3.0m Str
-2281 3.5m Str
-2282 4m Str
-2283 5m Str



Luxation Elevator
-2284 2mm Cvd
-2285 2.5m Cvd
-2286 3.0m Cvd
-2287 3.5m Cvd
-2288 4m Cvd
-2289 5m Cvd



Luxation Elevator
-2290 2mm Str
-2291 2.5m Str
-2292 3.0m Str
-2293 3.5m Str
-2294 4m Str
-2295 5m Str



Luxation Elevator
-2296 2mm Cvd
-2297 2.5m Cvd
-2298 3.0m Cvd
-2299 3.5m Cvd
-2300 4m Cvd
-2301 5m Cvd



Luxation Elevator
-2302 2mm Str
-2303 2.5m Str
-2304 3.0m Str
-2305 3.5m Str
-2306 4m Str
-2307 5m Str



Luxation Elevator
-2308 2mm Cvd
-2309 2.5m Cvd
-2310 3.0m Cvd
-2311 3.5m Cvd
-2312 4m Cvd
-2313 5m Cvd



**30-L
Cryer U.K.**
-2314



**31-R
Cryer U.K.**
-2315



**4.5m
Coupland #3**
-2316



**3.5m
Coupland #2**
-2317



**2.5m
Coupland #1**
-2318



**Hyllin-3
4m**
-2319



**Hyllin-2
3m**
-2320



**Hyllin-1
2m**
-2321



WWJ-L
-2322



WWJ-S
-2323



WWJ-R
-2324

ROOT ELEVATORS



Flohr-2L
2325



Flohr-1S
2326



Flohr-3R
2327



Kopp-2L
2328



Kopp-1S
2329



Kopp-3R
2330



Flohr-4mm
2331



Bein
2332 5.m
2333 5.5m
2334 6.0m



Bein
2335 3.5m
2336 4.m
2337 4.5m



Bein
2338 2.m
2339 2.5m
2340 3.m



Cryer 39-L
2341



Cryer 40-R
2342



Cryer 27L
2344



Cryer 28R
2345



Bein-Modif

2346-2m -2349-2m
2347-3m -2350-3m
2348-4m -2351-4m



Hylin-2S
-2352



Hylin-1S
2353



Hylin-3S
2354



Read
-2355



Fig-1P
2355



Fig-1S
2356



Fig-2LS
-2357



Fig-3RS
2358

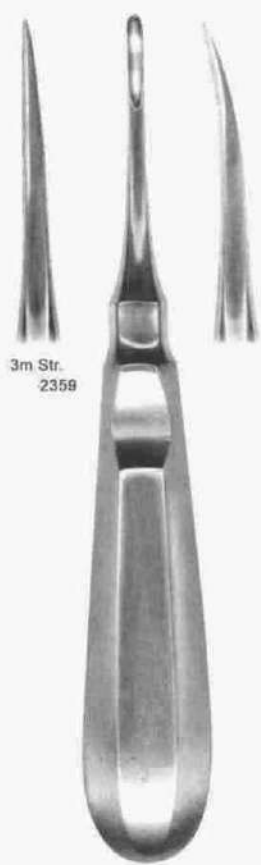

Khurmchi

3m Str.
2359



3m Cvd.
2360



5m Str.
2361



5m Cvd.
-2362



Lindo-Levin
-2363
Straight



2364



2365



W.F. Barry



Liclus-B 2366 Liclus-S 2367 Barry-11L 2368 Barry-12R 2369 Barry-17L 2370 Barry-18R 2371 Winter-14L 2372 Winter-14R 2373

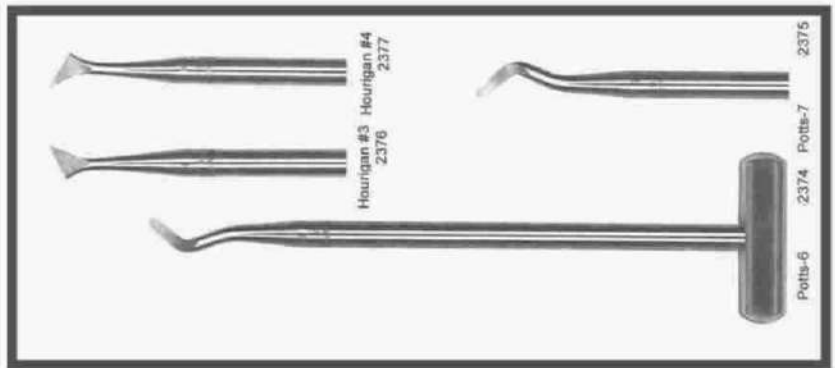

Hourigan #3 2376 Hourigan #4 2377 Potts-6 2374 Potts-7 2375

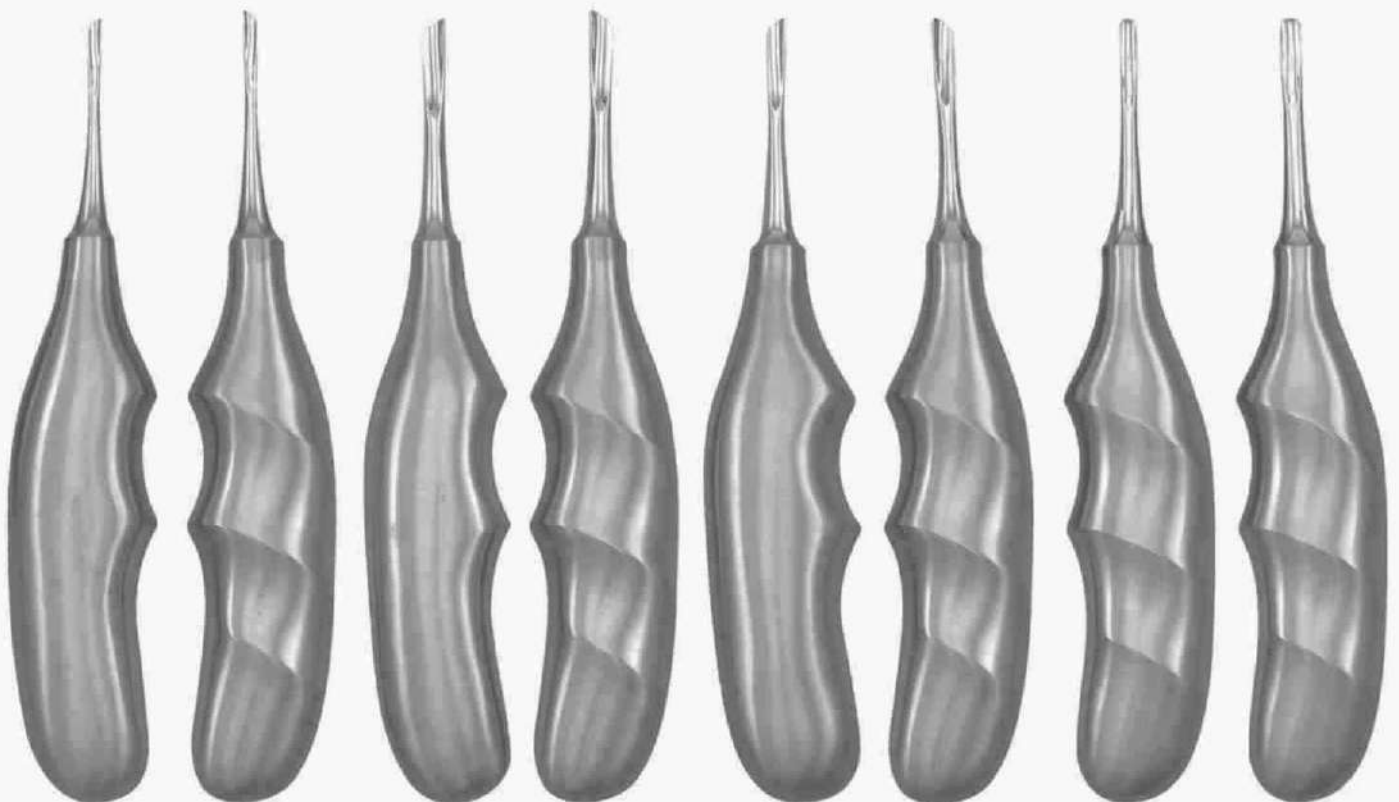

2.5m-L 2378 2.5m-R 2379 3.5m-L 2380 3.5m-R 2381 4.5m-L 2382 4.5m-R 2383 2.5m-S 2384 3.5m-S 2385

ROOT ELEVATORS

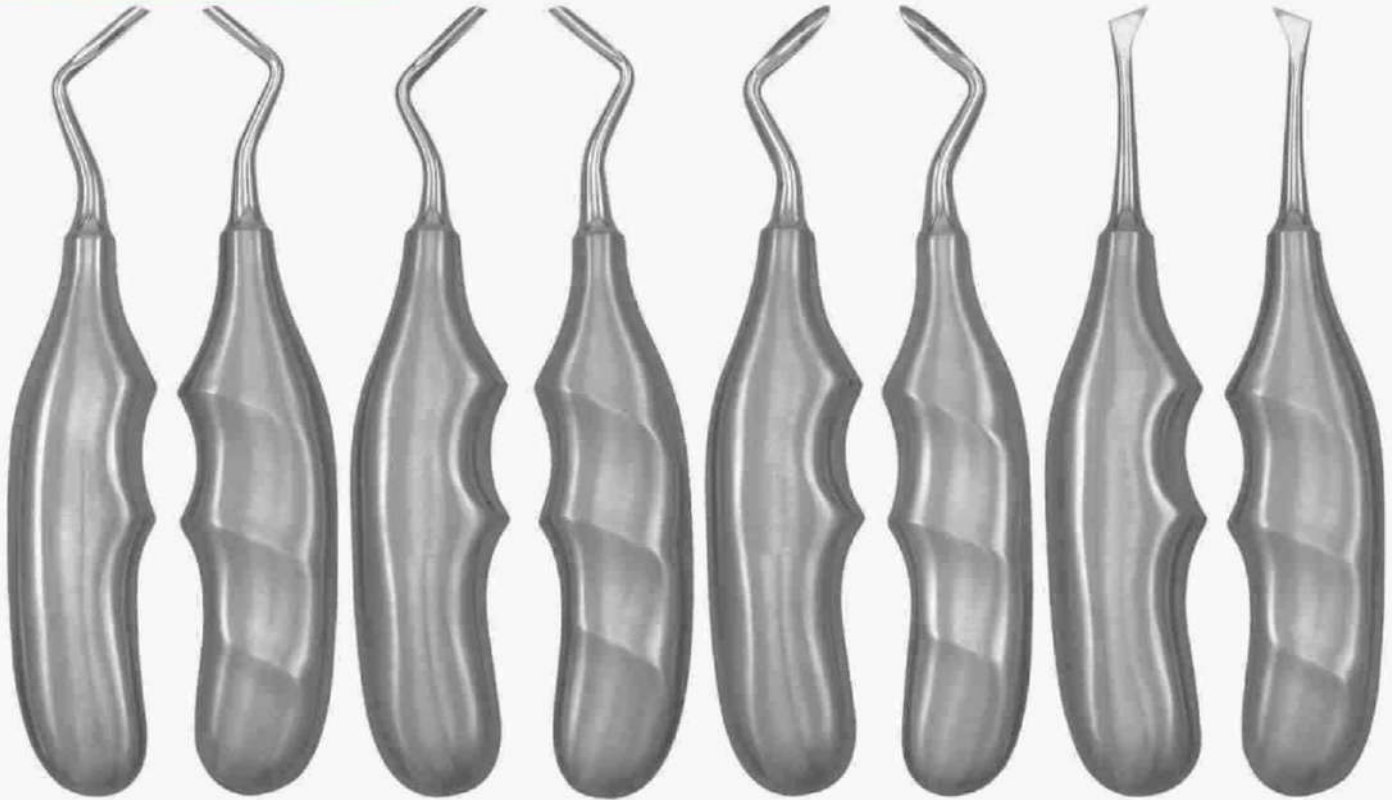

2.5m-L
-2386

2.5m-R
-2387

3.m-L
-2388

3m-R
-2389

-2390-L

-2391-R

Small-L
-2392

Small-R
-2393

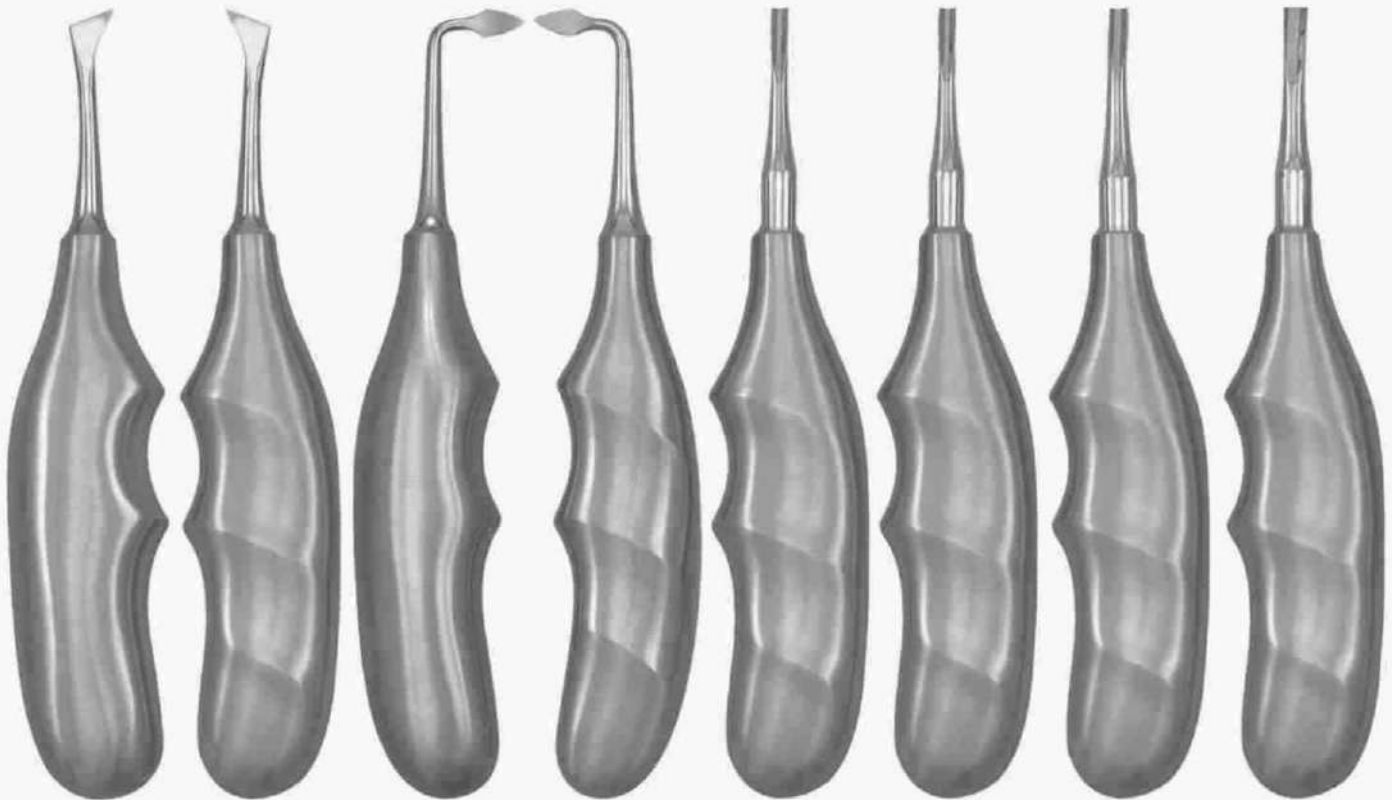

Large-L
-2394

Large-R
-2395

-2396-L

2397-R

2.5m
-2398

3m
-2399

4m
-2400

5m
-2401

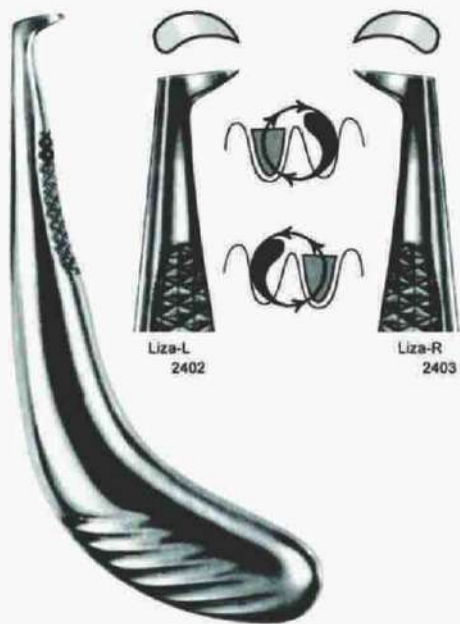

Liza



Trousse-1
Wise-2404

Trousse-2
-2405



Full Set
-2406



Hyllin 12cm
-2407 - 2m
Hyllin 16cm
-2408 - 2m



Crown-Spreader
Universal
-2409



Band Pusher
-2410



Band Adopter
-2411



-2412



-2413



-2414



-2425



-2426



GUM SCISSORS



IRIS-REGULAR-STR.
2627 10.5cm
2628 11.5cm
2629 12cm



IRIS-REGULAR-CVD.
2630 10.5cm
2631 11.5cm
2632 12cm



IRIS-FINE
2633 11.5cm Str.
2634 11.5cm Cvd.



LA-GRANGA
2635 11.5cm



IRIS WIDE RINGS
2636
12cm Str.



IRIS-WIDE RINGS
12 cm Cvd.
2627-A



LOCKING
11.5 cm
2628-A



LOCKLIN
11.5 cm
2629-A



IRIS ROUND STR.
11.5 cm
2630-A



IRIS ROUND CVD.
11.5 cm
2631-A



IRIS ROUND WIDE BLAD
11.5 cm Str. 11.5 cm Cvd.



IRIS LONG BLAD WIDE RINGS
12 cm Str. 12 cm Cvd.



IRIS WIDE BLAD
12 cm Str.



IRIS WIDE BLAD
12 cm Cvd.



LOCKLIN STRIP
11 cm

CROWN & GOLDMAN FOX SCISSORS

SICOP
Surgical Instruments
Co. of Pak



Stich
-2639



Stich Cut & Hold
-2640



Crown Straight
10.5cm -2641



Crown Curved
10.5cm -2642



Crown Straight
10.5cm -2643



Crown Curved
10.5 cm 2644



Crown Straight
10.5 cm 2645



Crown Straight
10.5 cm 2646



Crown Curved
10.5 cm 2647



Universal Wire
12 cm 2648



Goldman Fox Straight
13 cm 2649



Goldman Fox Curved
13 cm 2650



Goldman Fox Mod
13 cm -2651



Goldman Fox Straight
13 cm -2652



Goldman Fox Curved
13 cm 2653



Dressing B / B

- 2654-14cm Str.
- 2655-15cm Str.
- 2656-16cm Str.

- 2657-14cm Cvd.
- 2658-15cm Cvd.
- 2659-16cm Cvd.



Dressing S / B

- 2660-14cm Str.
- 2661-15cm Str.
- 2662-16cm Str.

- 2663-14cm Cvd.
- 2664-15cm Cvd.
- 2665-16cm Cvd.



Dressing S / 5

- 2666-14cm Str.
- 2667-15cm Str.
- 2668-16cm Str.

- 2669-14cm Cvd.
- 2670-15cm Cvd.
- 2671-16cm Cvd.



Mayo

- 2672-14.5cm Str.
- 2673-15.5cm Str.
- 2674-16.5cm Str.

- 2675-14.5cm Cvd.
- 2676-15.5cm Cvd.
- 2677-16.5cm Cvd.



Metzenbaum Str.

- 2678
- 2679
- 2680



Metzenbaum Cvd.

- 2681 14.5 cm
- 2682 15.5 cm
- 2683 16.5 cm



Fine Metzenbaum

- | | |
|----------|---------|
| Straight | Curved |
| 2684 | 2685 |
| 14.5 cm | 14.5 cm |



Delicate Metzenbaum

- | | |
|----------|---------|
| Straight | Curved |
| 2686 | 2687 |
| 14.5 cm | 14.5 cm |



Stich Angled

- 2688 12 cm
- 2689 14 cm
- 2690 16 cm



Stich Straight

- 2691 12 cm
- 2692 14 cm
- 2693 16 cm



Quinby
16cm Str. 16cm Cvd.
2694 2695

Kelly
Str. 16cm
2696

Kelly Cvd.
Cvd. 16cm
2697

Kelly Angled
Cvd. 16cm
2698

Shelley
15cm 2699

Neumann
12cm 2700
16cm 2701



Dean
17cm 2702

Locklin
16cm 2703

Gillies
15cm 2704

Bandage
14cm 2705
15cm 2706
16cm 2707

Sammi
14cm 2708
15cm 2709
16cm 2710



IRIS WIDE RINGS
Str. 11.5cm
-2711



IRIS WIDE RINGS
Cvd. 11.5cm
-2712



IRIS ROUND
Str. 11.5cm
-2713



IRIS ROUND
Cvd. 11.5cm
-2714



IRIS FINE
Str. 11.5cm / Cvd. 11.5cm
-2715



LA GRNGA
11.5cm -2716



LOCKING
11.5cm -2717



LOCKING
11.5cm -2718



CROWN
Str. 10.5cm -2719



CROWN
Cvd. 10.5cm -2720



CROWN
Str. 10.5cm -2721



CROWN
Cvd. 10.5cm -2722



COLLAR
Str. 10.5cm -2723



CROWN
Str. 10.5cm -2724



CROWN
Cvd. 10.5cm -2725



Goldman Fox
Str. 13cm
2726



Goldman Fox
Cvd. 13cm
2727



Goldman Fox Mod
13cm 2728



Goldman Fox
Str. 13cm 2729



Goldman Fox
Cvd. 13cm 2730



Dressing B/B
Str. 15cm 2731
Cvd. 15cm -2732



Dressing S/B
Str. 15cm 2733
Cvd. 15cm -2734



Dressing S/S
Str. 15cm -2735
Cvd. 15cm -2736



Mayo
Str. 15cm -2738
Cvd. 15cm -2739



Metzenbaum
Str. 14.5cm
2740



TC SCISSORS



Metzenbaum
14.5cm Cvd.
2741



Metzenbaum Fine
14.5cm Str.
2742



Metzenbaum Fine
14.5cm Cvd.
2743



Kelly Angled
16cm 2744



Shelley
15cm 2745



Kelly
16cm 2746



Dean
17cm 2747



Locklin
16cm 2748



Utility
14.5cm 2749
15.5cm 2750
16.5cm 2751



Universal
12cm 2752



Barraquer
Str. 14cm
2753
Cvd. 14cm
2754



Potts-Smith
22cm 2755



Barraquer
-2756 13cm Str.
-2757 15cm Str.
-2758 16cm Str.
-2759 18cm Str.

2760 13cm Cvd.
2761 15cm Cvd.
2762 16cm Cvd.
2763 18cm Cvd.



Castroviejo Needle Holder
-2764 14cm Str.
-2765 18cm Str.

2766 14cm Cvd.
2767 18cm Cvd.



**Castroviejo
N.H. Angled**
2768



Castroviejo Iris
2769 9cm Str.
2770 10.5cm Str.

2771 9cm Cvd.
2772 10.5cm Cvd.



Westcott
2773 11cm Str.
2774 11cm Cvd.



Barraquer
2778
14cm Str.
2779
14cm Cvd.



Potts-Smith
22cm
2780 (Plain)
2781 (Serrated)



Barraquer
2782-13cm Str.
2783-15cm Str.
2784-16cm Str.
2785-18cm Str.



Castroviejo N.H.
2786-13cm Cvd.
2787-15cm Cvd.
2788-16cm Cvd.
2789-18cm Cvd.



**Castroviejo
N.H. Angled**
2794



Castroviejo Iris
2795 9cm Str.
2796 10.5cm Str.
2797 9cm Cvd.
2798 10.5cm Cvd.



Westcott
2799 11cm Str.
2800 11cm Cvd.



SPLINTER FORCEPS



Roshoo
12.5cm



2801



2803



2802



2804

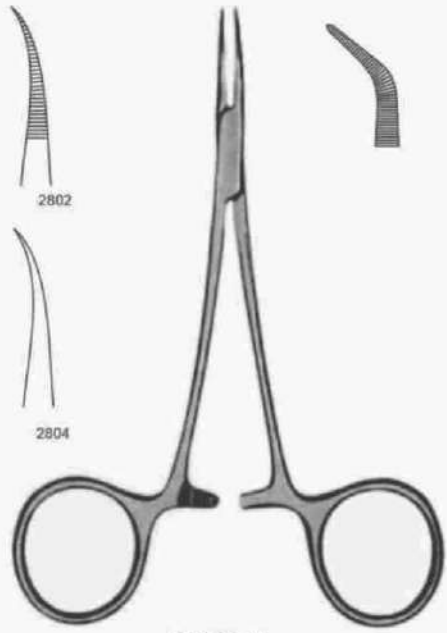

Peet-Blunt
11.5cm
Wise-2805



Peet-Sharp
11.5cm
Wise-2806

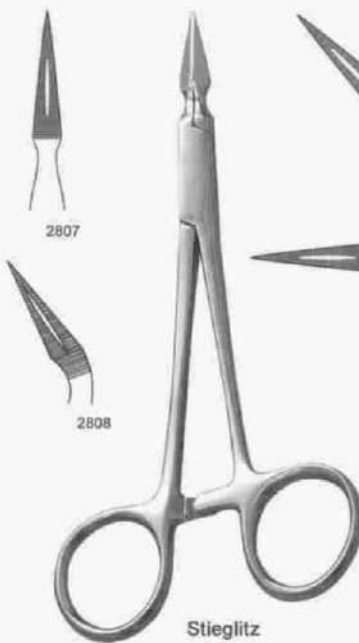

Stieglitz
13.5cm



2807



2808



2809



2810

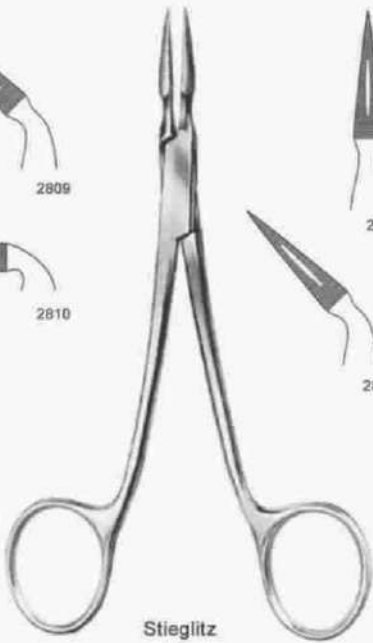

Stieglitz
13.5cm



2811

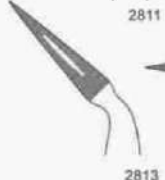

2813



2812



2814

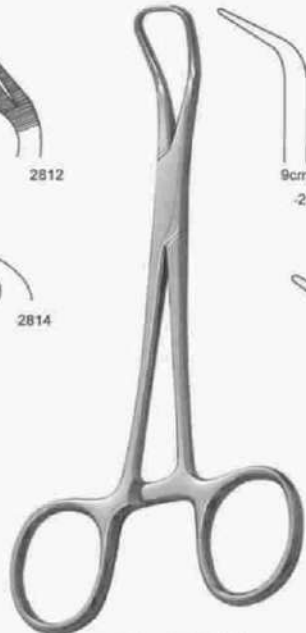

Backhaus Towel



9cm
-2815



11cm
-2816



13cm
2817

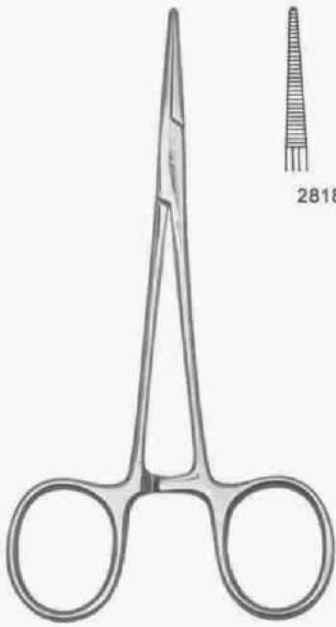

2818

Halstead Mosquito
12.5cm Str.

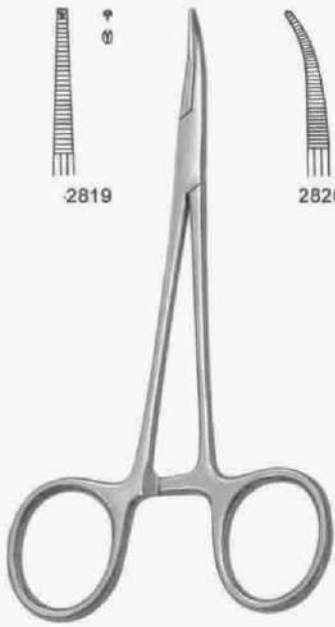

2819

Halstead Mosquito
12.5cm Cvd.

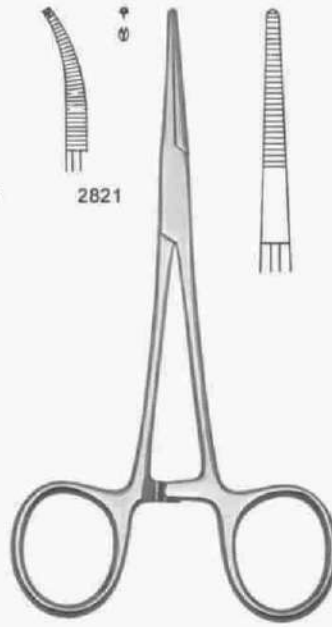

2820

Kelly
2822
14cm Str.

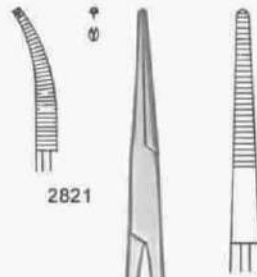

2821



Kelly
2822
14cm Cvd.

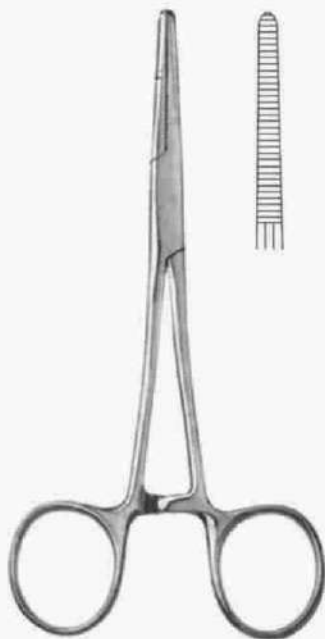

Spencer Wells
2824
12.5cm Str.



Spencer Wells
2825
12.5cm Cvd.

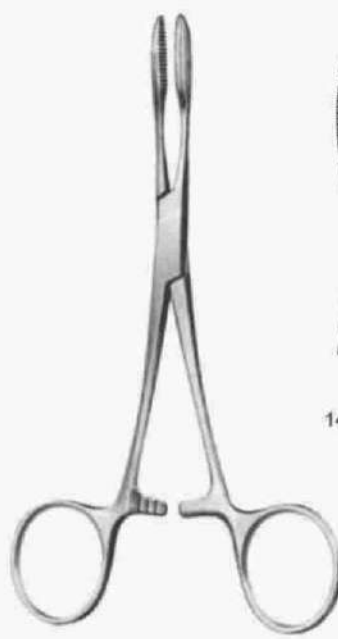

2826
14cm



2827
16cm

Pean Wide



Halsey
12.5cm

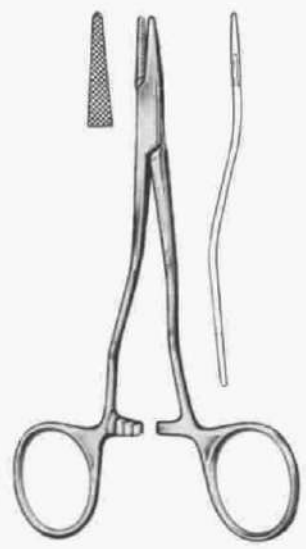

Kilner
2830
12.5cm

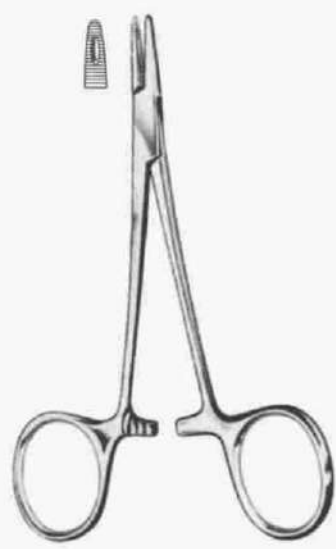

Derf
-2831
12cm

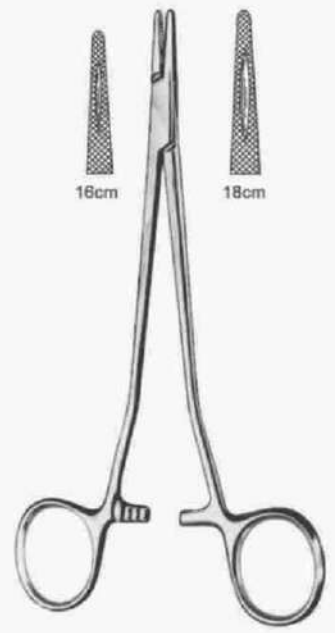

Sarot
2832
16cm
2833
18cm



**Mayo Hegar Needle
Holder Joint Off**
2834 15cm
2835 16cm



Crile Wood Needle Holder
-2836
15cm



**Mayo Hegar
Needle Holder**

Regular

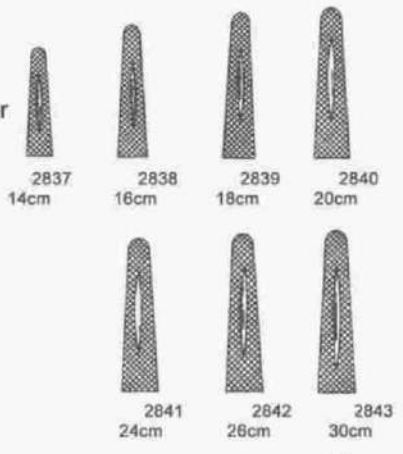

Delicate

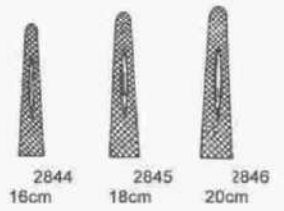

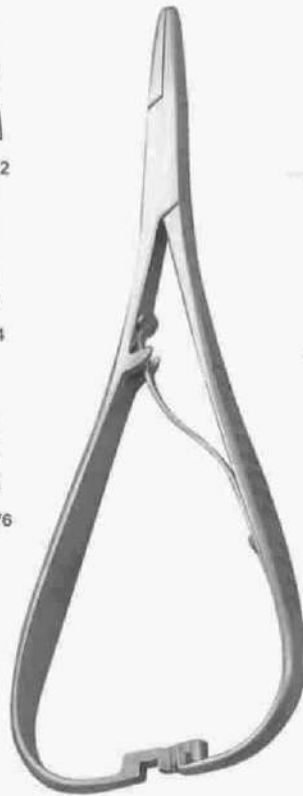

Mathieu Needle Holder

Mathieu Needle Holder

Mathieu Delicate
-2883
15cm str





T.C MATHIEU NEEDLE HOLDERS



Mathieu Needle Holder



**Mathieu Needle Holder
Joint Off**



Arruga
-2909 - 16cm str.
-2910 - 16cm cvd.



Ryder



Axhausen
-2913
18cm



Toennis
2914
18cm



Langenbeck
-2915-18cm
-2916-20cm



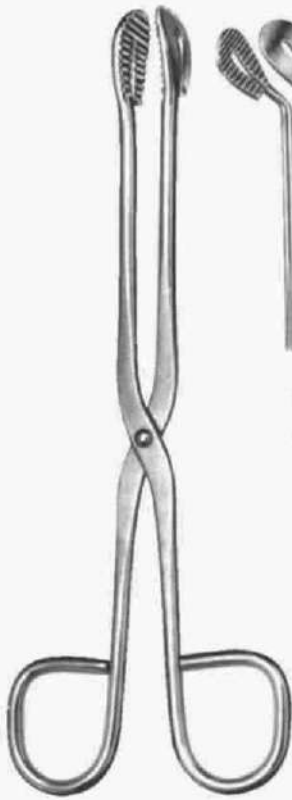

Jessman
2917-20cm
2918-30cm



2919
20cm
2920
30cm



Seti-Set
2921-20cm
2922-30cm



Rogge
2923-20cm
2924-30cm



Cheattle
2925
28cm



2926
16cm



2927
16.5cm



2928
16cm



Burnet
2929



S.S. Brush
2930



TWEEZERS



Adson
12cm

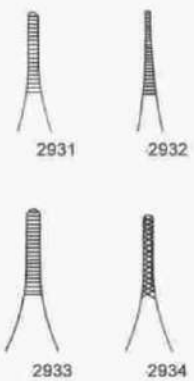

Adson
12cm

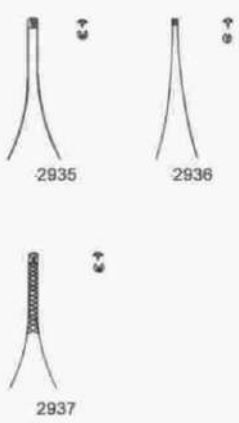

Adson
16cm

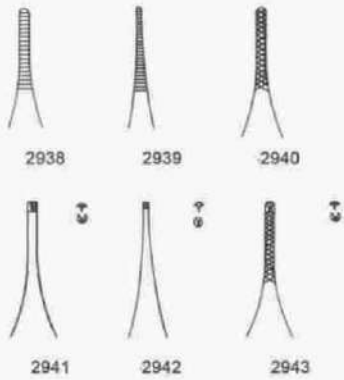

Adson Brown
12cm



Semkin
12.5cm

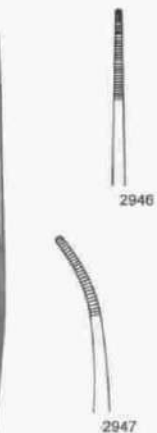

Iris
12.5cm



Dressing
18cm

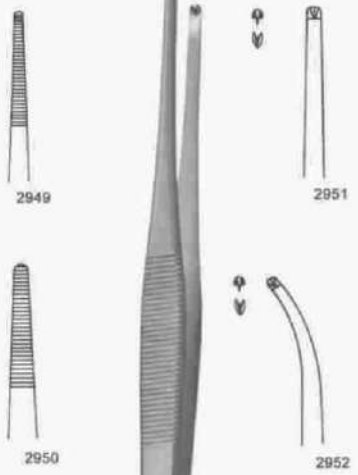

Kocher
18cm



Feilche Needle
2953
9cm



Splinter
11.5cm



Jeweleris
Fig.1
2958



Jeweleris
Fig.5
-2959



Jeweleris
Fig.7
-2960



Jeweleris
Fig.5/90
2961



Cushing
2962
15cm



Fox
2963
15cm



Fox-Locking
2964
15cm



Holding-Locking
2965
16cm



Russian
2966
15cm



Roots-FRA
2967
16cm



SUTURE & ARTICULATOR TWEEZER



Schdual Towel
2968
9cm



Suture Tweezer
2969
15.5cm



2970



2971



Suture Tweezer
2972
15.5cm



Suture Tweezer
2973
15cm



Crane-Caplan
2974
15cm



2976



2978



Articulator
Miller Paper
2977
15cm str.

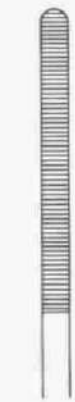

Wise-2975



Wise-2976



Miller Articulator Paper
2977



De Bakey
2978-16cm str.
2979-16cm cvd.



Solder
2980
15cm str.



Solder
2981
15cm cvd.

Direct Bonding Bracket Holders

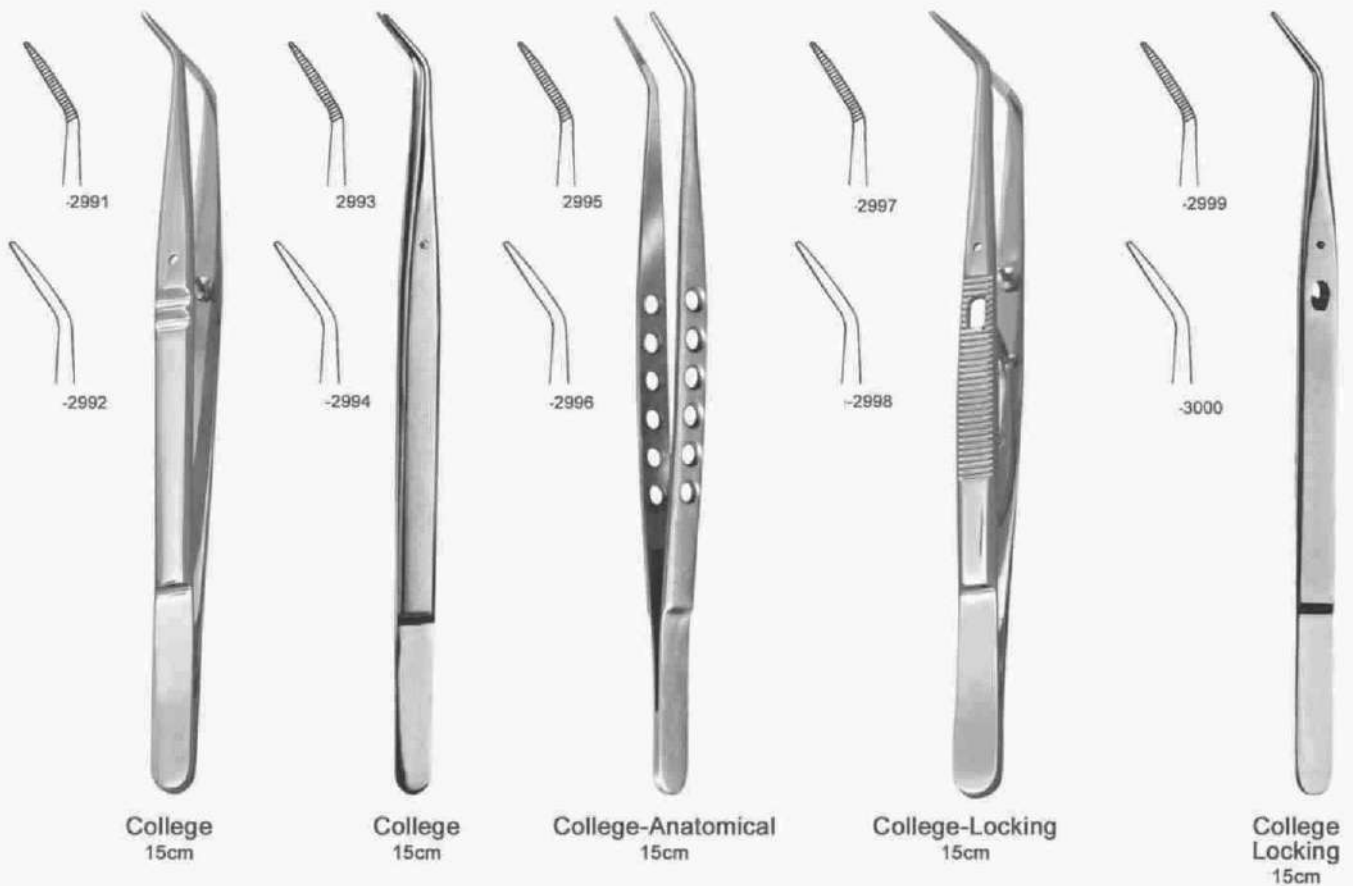
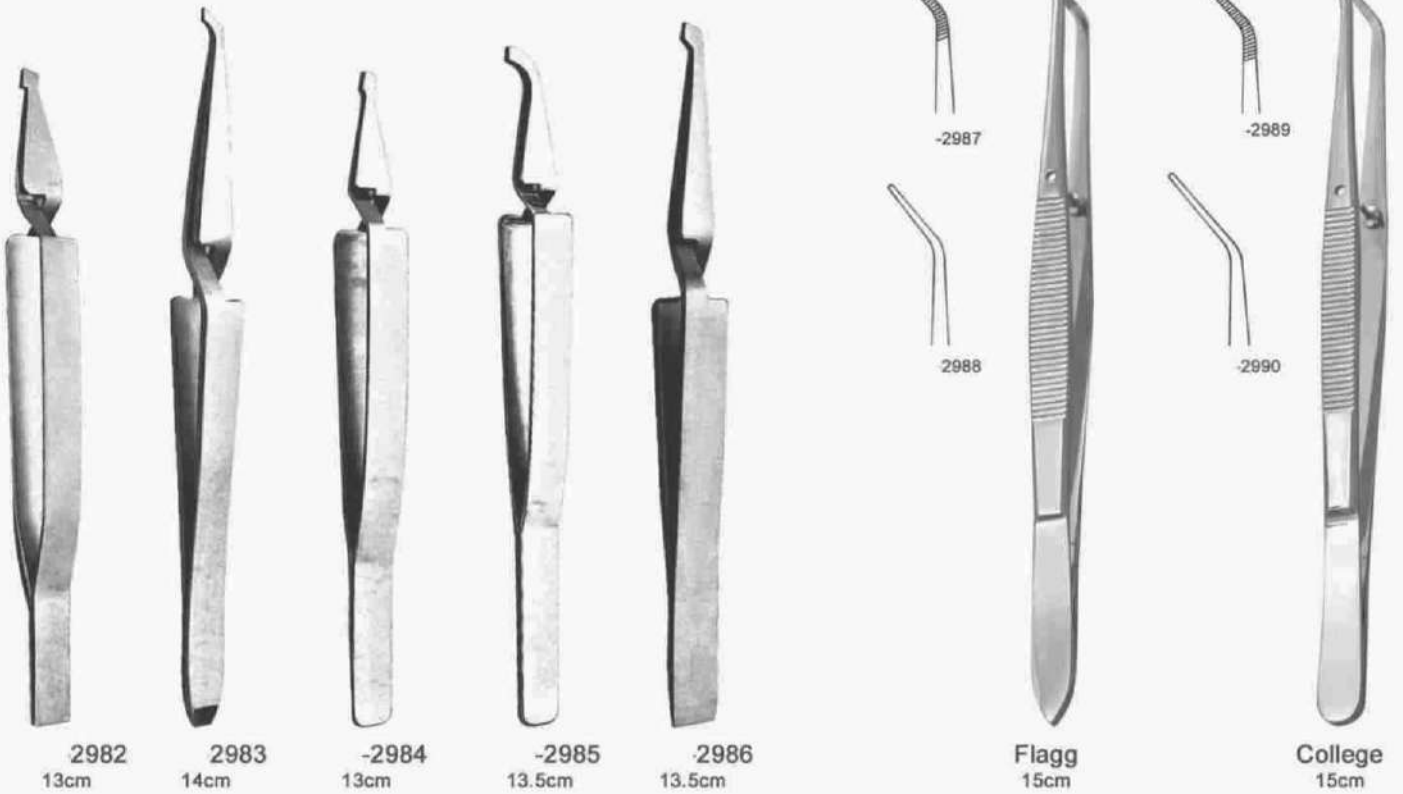



COTTON PLIERS & T.C TWEEZERS



3001



Grove-Locking
15cm



3002



Grove-Locking



-3003



-3004



Meriam
16cm



-3005



-3006



Meriam
16cm



-3007



-3008



Meriam
16cm



-3009



-3010



Meriam
16.5cm



-3011



-3012



Meriam-Locking
16cm



-3013



-3014



College
Roung-Angled



College
Diamond Point



-3016



-3017



-3018



-3019



Adson

-3015

CROWN REMOVER & SPREADERS

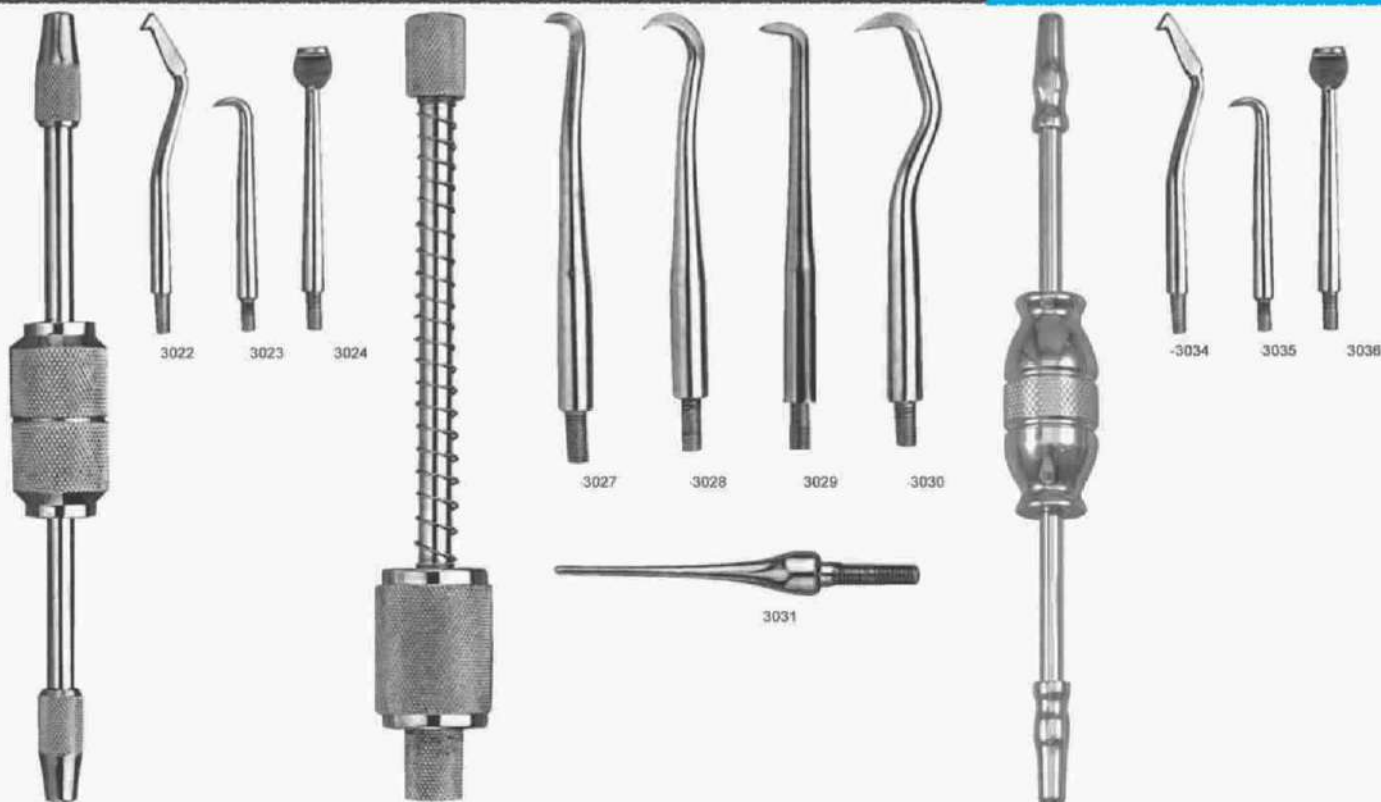

Manual Crown Remover with 3 tips
3020
only handle 3021

Reversible Crown Remover with 5 tips
3025
only handle 3026

Manual Crown Remover with 3 tips
3032
only handle 3033



Manual Crown Remover with 4 tips
3037
only handle 3038

Automatic Crown Click with 2 tips
3043
only handle 3044

Adjustable Intensity Crown Remover with 4 tips
3047
only handle 3048

Aspirating Crown Spreader
3052

BONE CURETTES & FILES



3053 Miller-45



3054 Miller-21



3055 Miller Colburn-3X



3056 Miller Colburn-2X



3057 Miller Colburn-1X



3058 Miller-52



3059 Miller-64

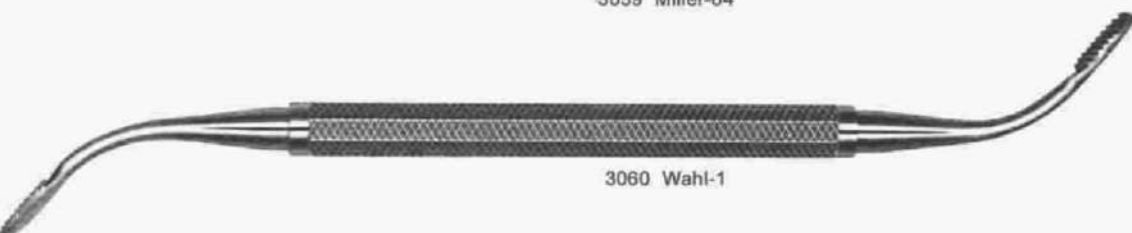

3060 Wahl-1



3061 Wahl-2



3062 Howard-12



3063 Howard-67



3064 Allen-9A



3065 Prichard-3/9A



3066 OHL-10



Gardner
17cm

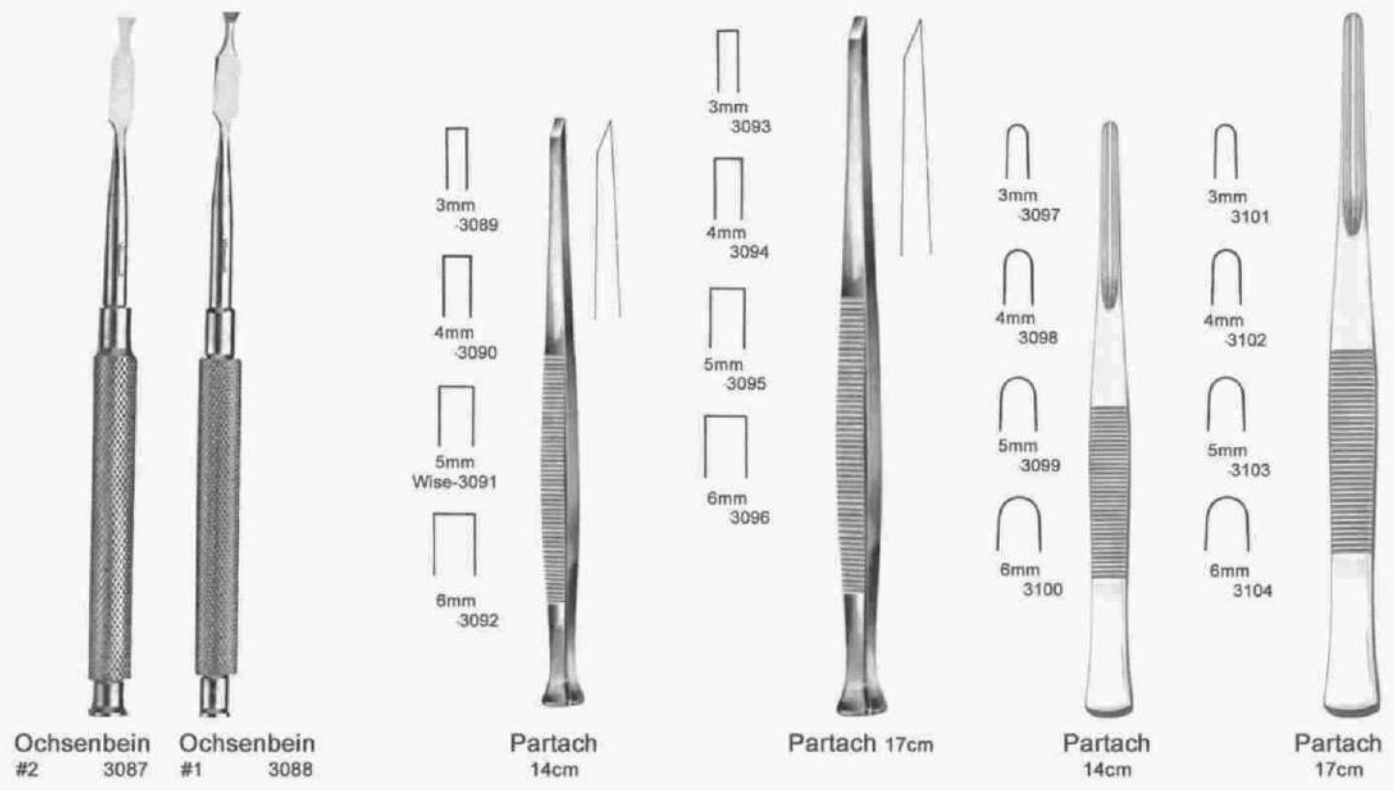

Ochsensbein
#2 3087

Ochsensbein
#1 3088

Partach
14cm

Partach
17cm

Partach
14cm

Partach
17cm





Heister
3119
13cm



Doyen-Jansen
3120
14cm



Doyen-Collin
3121
12cm



Molt
3122
10cm

FINGER PROTECTOR



Langen Beak Small
3123



Langen Beak Medium
3124

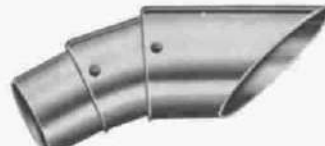

Langen Beak Large
3125



Ackland
3126
14.5cm



Denhart
3127
12.5cm



Roser-Konig
3128-16cm
3129-18.5cm



**Tounge Depressors
& Check Retractor**
3130





TONGUE DEPRESSORS & CHECK RETRACTORS



Bruenings
3131
19cm

Buchwald
3132
18.5cm

Frenzel
3133
16.5cm

-3134

3135

-3136



Wise-3137

-3138

-3139

3140

3141

Regnal Devis
-3142
15cm

Farabeuf
3143-12.5cm
3144-15cm

Farabeuf
3145-12.5cm
3146-15cm

Roux
28mm 3147
38mm 3148

29mm
26mm
22mm

Small
Medium
Large

RETRACTORS

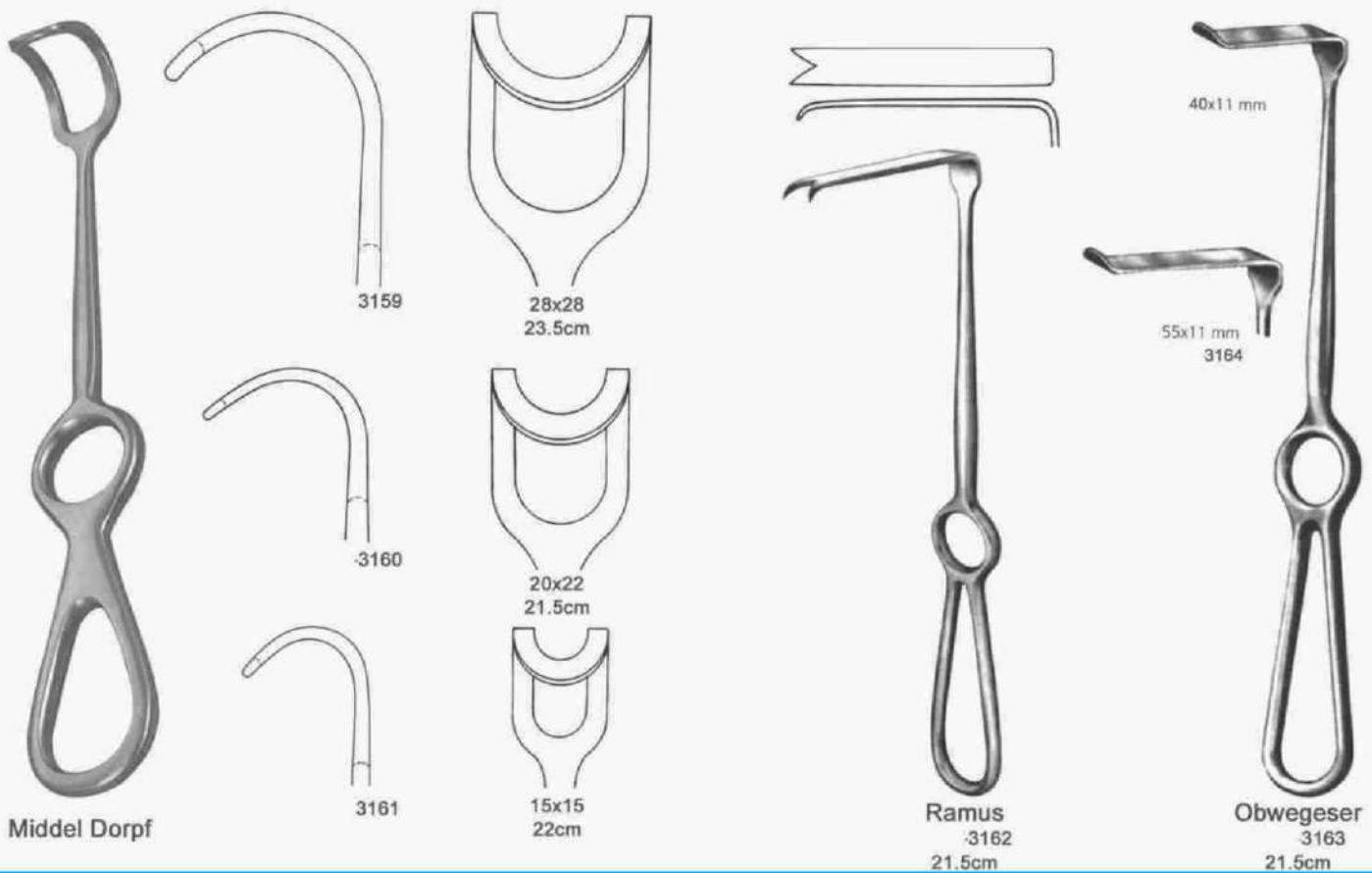
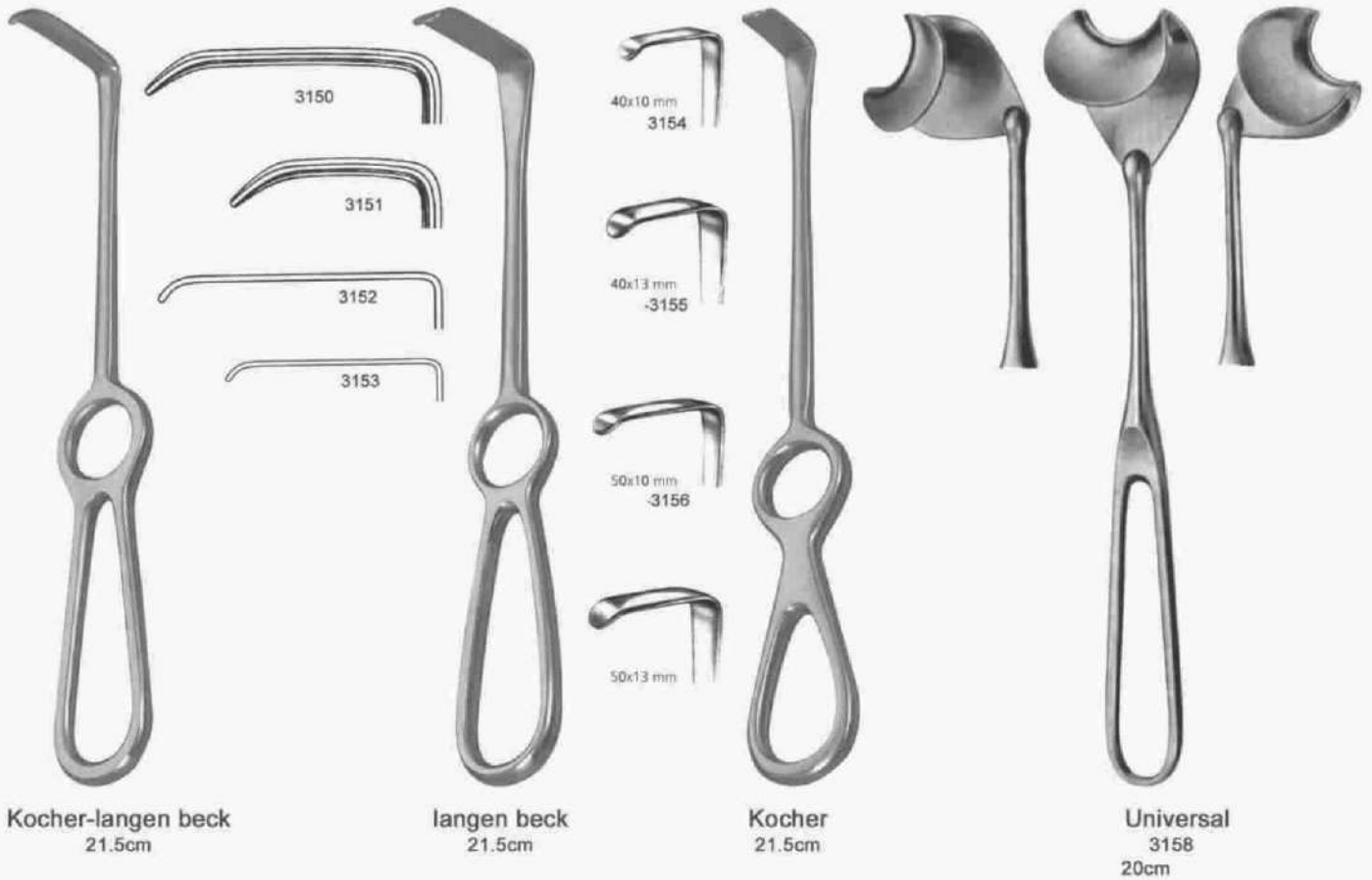



CHECK/LIP RETRACTOR & MOUTH GAGS



Large
3165



Small
3166



KDF Large
3167



Flexible Large
3168



Small 3169 **Medium** 31670 **Large** 31671



31672



Sternberg
3173-13cm
3174-15cm



Sternberg
3175-13cm
3176-15cm

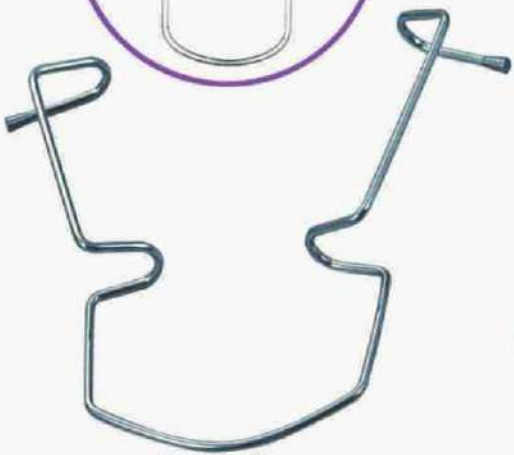

Standard
3177

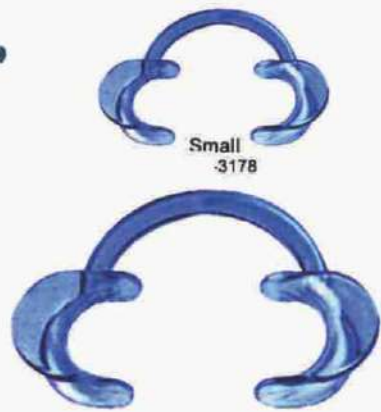

Large
3179



Ivory
-3180
16cm



Ainsworth Flat Anatomical
-3181
16cm



Ainsworth Round
Anatomical
3182
16cm



Ainsworth
3183
16cm



Brewer
3184
17.5cm



White
3185
17.5cm

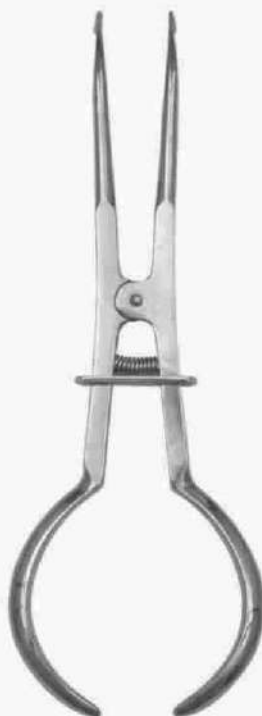

Palmer
3186
17.5cm



Stockes
3187
17.5cm



Elastic Separator
3188
17.5cm



RUBBER DAM & CLAMP



Ivory
3189
17cm



Ivory
3190
17cm



Ring Adoptor
3191
17cm

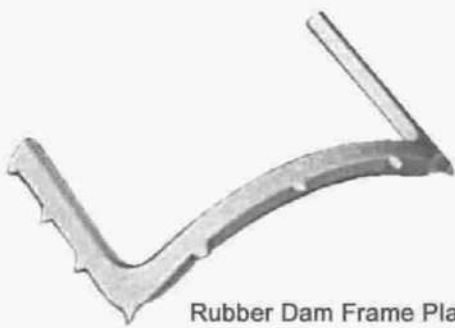

Rubber Dam Frame Plastic
3192

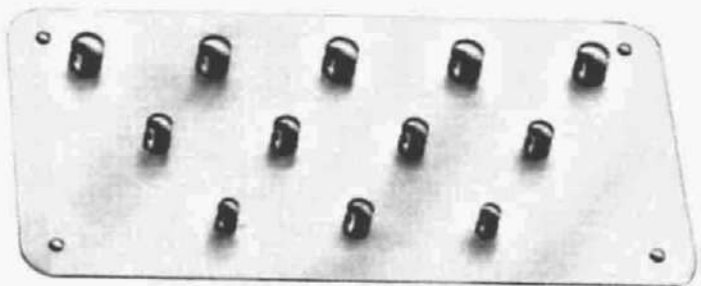

Dam Plate
3193

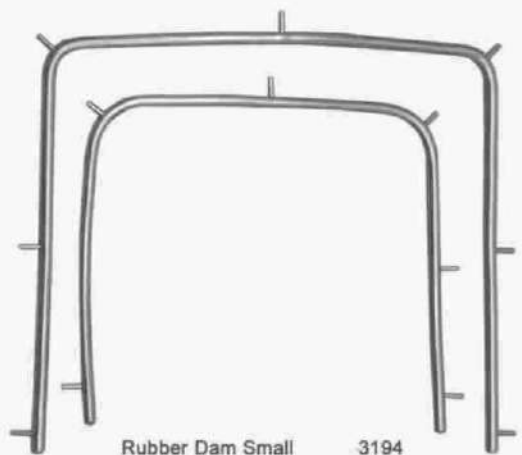

Rubber Dam Small 3194
Rubber Dam Large 3195



Articulating Paper
Tweezer 3196



Articulating Paper
Tweezer 3197



Fig.0
-3198



Fig.2A
-3199



Fig.3
-3200



Fig.4
-3201



Fig.5
-3202



Fig.8
-3203



Fig.8A
-3204



Fig.W8A
-3205



Fig.12A
-3206



Fig.13A
-3207



Fig.14
-3208



Fig.14A
-3209



Fig.W14
-3210



Fig.W14A
-3211



Fig.15
-3212



Fig.18
-3213



Fig.22
-3214



Fig.24
-3215



Fig.25
-3216



Fig.26
-3217



Fig.28
-3218



Fig.29
-3219



Fig.30
-3220



Fig.31
-3221



Fig.51
-3222



Fig.138
-3223



Fig.139
-3224



Fig.200
-3225



Fig.201
-3226



Fig.202
-3227



Fig.203
-3228



Fig.204
-3229



Fig.205
-3230



Fig.206
-3231



Fig.207
-3232



Fig.208
-3233



Fig.209
-3234



Fig.210
-3235



Fig.211
-3236



Fig.212
-3237



Fig.0
-3238



Fig.1
-3239



Fig.1A
-3240



Fig.2
-3241



Fig.2A
-3242



Fig.3
-3243



Fig.4
-3244



Fig.5
-3245



Fig.9
-3246



Fig.7
-3247



Fig.7A
-3248



Fig.8
-3249



Fig.8A
-3250



Fig.12
-3251



Fig.12A
-3252



Fig.13
-3253



Fig.13A
-3254



Fig.14
-3255



Fig.14A
-3256



Fig.15
-3257



Fig.9T
-3258



Fig.18
-3259



-3260



Fig.20
-3261



Fig.22
-3262



Fig.26
-3263



Fig.27
-3264



Fig.56
-3265



Fig.90N
-3266



Fig.203
-3267



Fig.207
-3268



Fig.209
-3269



Fig.212
-3270



Fig.212SA
-3271



3272



3273



Ivory
-3274



Elliot
3275



Ivory
-3276



Ivory
-3277



SQ Clamp Wide
-3278
8m



SQ Clamp Wide
-3279
5m



-3280



-3281



-3282



TOFF-Universal
-3283



TOFF-Junior
-3284



TOFF-Junior
Angled
-3285



Boley
-3286



Boley
-3287



Beerendonk
-3288



#1
-3289



#2
-3290

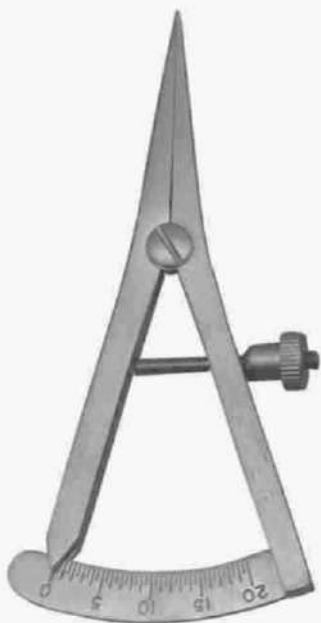

Castroviejo
3291



Iwanson Calipee
-3292



-3293



Interlock Measuring Gage
3294

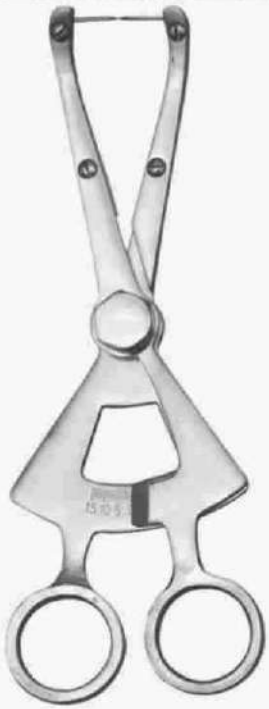

3
3295



4
3296



Zielinsky
3297

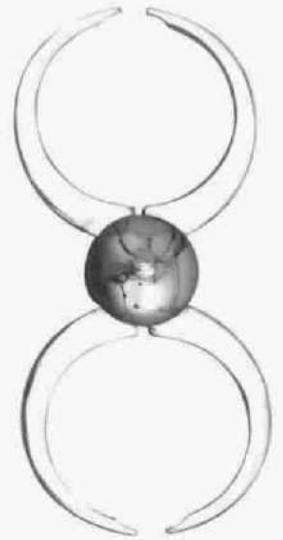

5
3298



3300

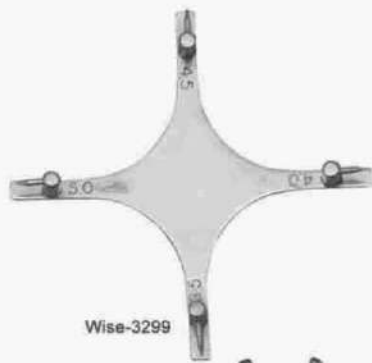

Wise-3299



Wise-3303



3305



3306



3307



Endo Finger Gage
3301



Endo Finger Roller
3302



3304



3308



FAHNENSTOCK

LESSIMAN

FAHNENSTOCK

LESSIMAN



WAX-S -3809 13cm	WAX-S -3810 13cm	WAX-S -3811 13cm	3812 13cm	-3813 13cm	Wax-L -3814 17cm	Wax-L -3815 17cm	Wax-L 3816 17cm	Wax-L -3817 17cm	Wax-L -3818 17cm	Wax-L 3819 17cm	Sachs -3820 19cm	Ermert -3821 12.5cm	Antkoviak 3822 12.5cm
------------------------	------------------------	------------------------	--------------	---------------	------------------------	------------------------	-----------------------	------------------------	------------------------	-----------------------	------------------------	---------------------------	-----------------------------



3823 3824 3825 3826 3827 3828 3829 3830 3831 3832

MIXING SPATULAS FOR PLASTER

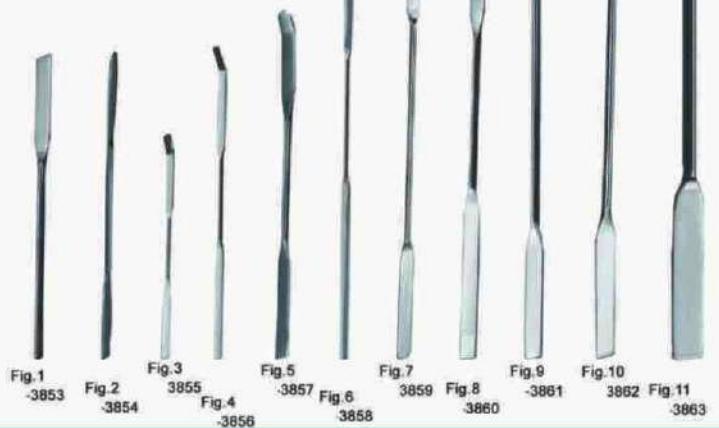

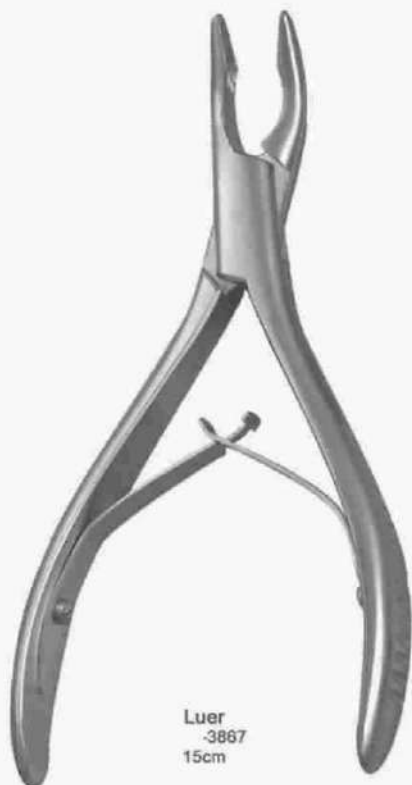
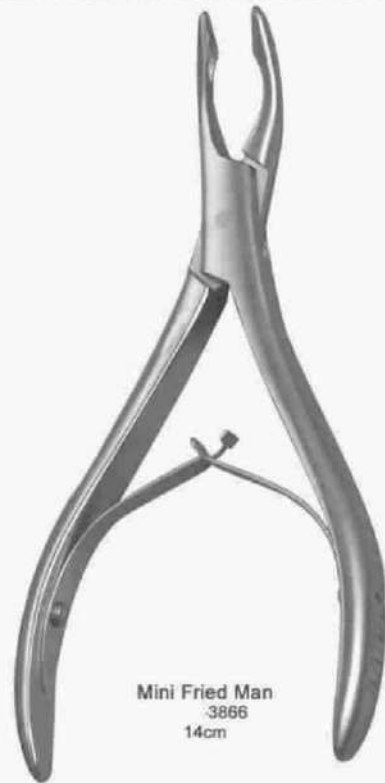



Hartmann
3870
15.5cm



Blumenthal 45-
-3871

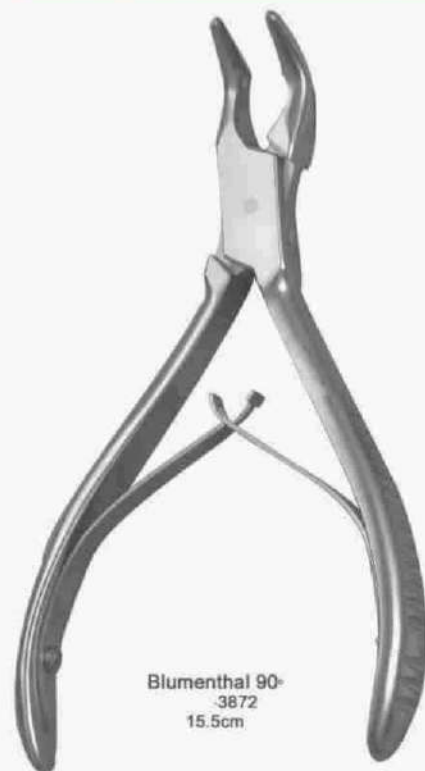

Blumenthal 90-
-3872
15.5cm

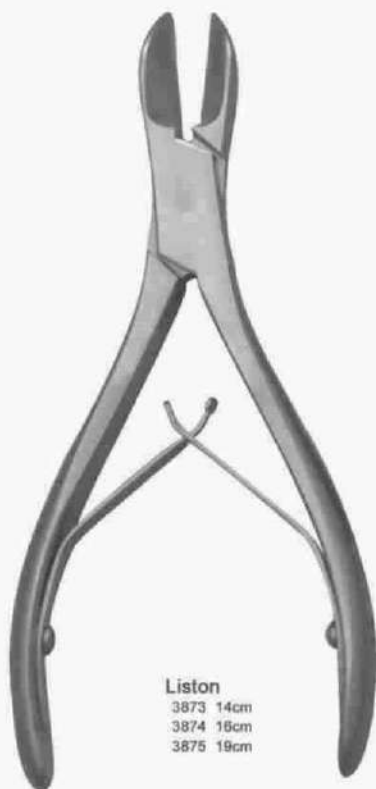

Liston
3873 14cm
3874 16cm
3875 19cm

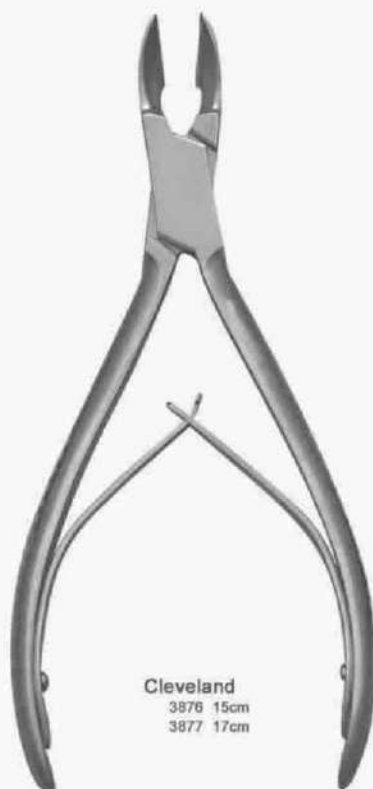

Cleveland
3876 15cm
3877 17cm

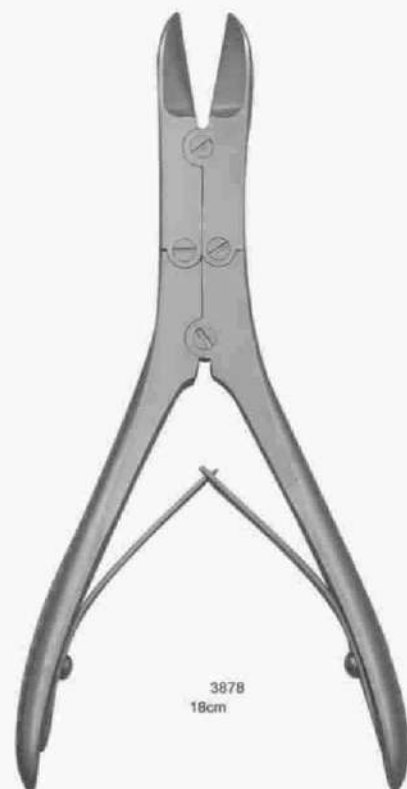

3878
18cm



Cleveland
3879
20cm



Beyer
3880
18cm



Top Cut
3881
20cm



Cut
3882
20cm



3883
19cm



3884



3885



3886



Universal
15.5cm



3887



3888



Universal
14.5cm



-3889



-3890



Universal
14.5cm



-3891



-3892



3893



3894
14.5cm



3895
14cm



-3896
14cm



-3897
14.5cm



Distal Cutter
14cm
3898 2.5m
3899 3m
3900 4m



Distal Cutter
14cm
3901 2.5m
3902 3m
3903 4m



Gum & Tissue Cutter
14cm
3904



Young EC
14.5cm
3905



Young
14.5cm
3906



Waldsachs
15cm
3907



Tweed
14.5cm
3908



O'Brien
13.5cm
3909

WIRE BENDING PLIERS



MC Kellops
16cm
3910



Schwarz
14.5cm
3911



Schwarz
13cm
3912



Schwarz
13cm
3913



Adams
14cm
3914

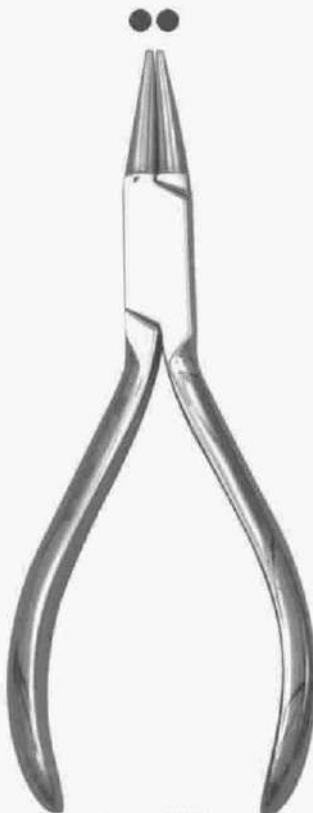

Langenbeck
14cm
3915



Langenbeck
14cm
3916



Angle
12.5cm
3917



BAND & CROWNS PLIERS



Oliver
14.5cm
3918



Aderer
14cm
3919



Tuttle
14cm
3920



Anterior Band Remover
13.5cm
3921



14.5cm
3922



15cm
3923



Furrer
14.5cm
3924

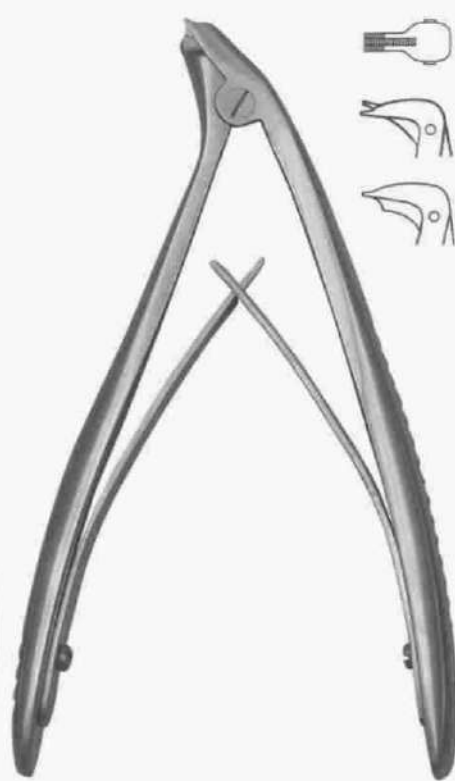

Crown Opener
15cm
3925



BAND & CROWN PLIERS

SICOP
Surgical Instruments
Co. of Pak



Bhom
14.5cm
3926

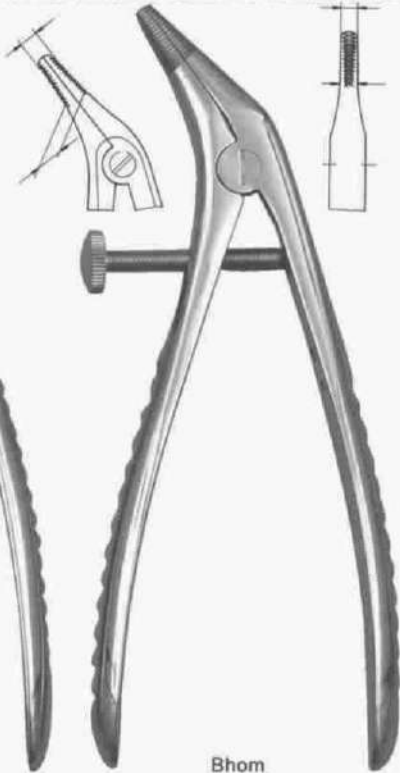

Bhom
12.5cm
3927



Abell Narrow
3928



Abell
13.5cm
3929



Bickinson
13cm
3930



Nance
14cm
3931



Aderer
14cm
3932



Oliver
12cm
3933



WIRE BENDING & LIGATURE PLIERS



Nance
12.5cm
3934



Aderer
13.5cm
3935-L



Aderer
13cm
3936-M



Aderer
12.5cm
3937-S



How
14cm
3938



How
13.5cm
3939



How
15cm
3940



How
15cm
3941



Nerve Canal
14cm
3942

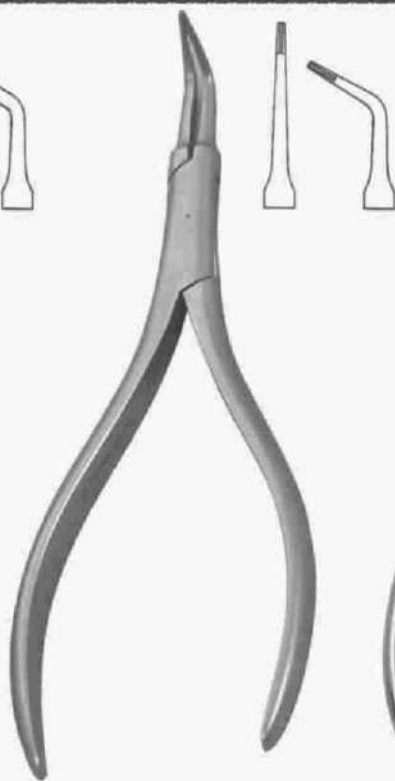

Nerve Canal Narrow
12.5cm
3943



Weingart
13.5cm
3944



Weingart Orthd
3945



Reynolds
13cm
3946



Johson
13cm
3947



Frevt
12.5cm
3948



Frevt
12cm
3949



Arch Bending
12.5cm
3950

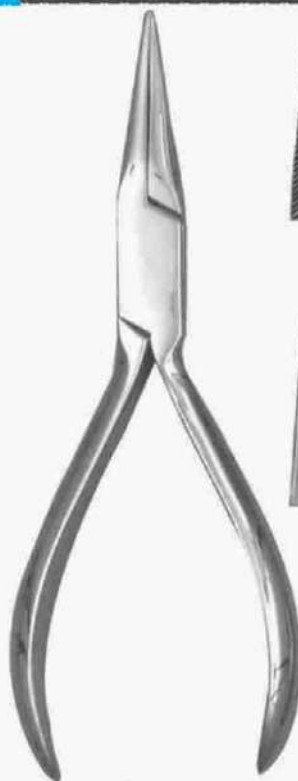

Aderer
12.5cm

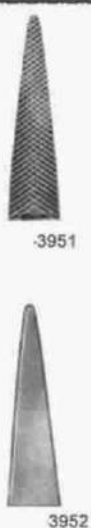

3951



3952



Aderer Narrow
12.5cm

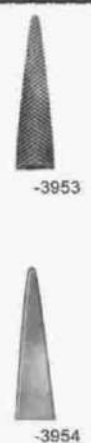

3953



3954

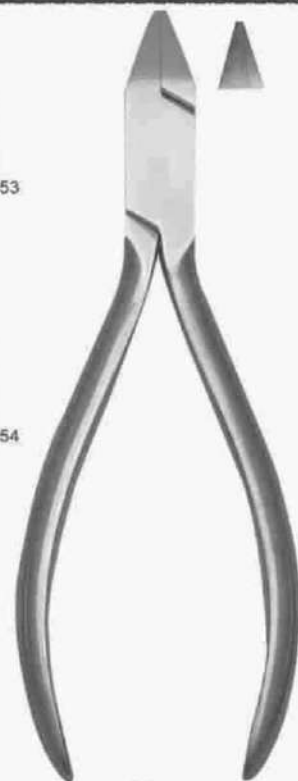

Adams
14.5cm
3955



Waldron
12.5cm
3956



Schwarz 12cm 12cm
3957

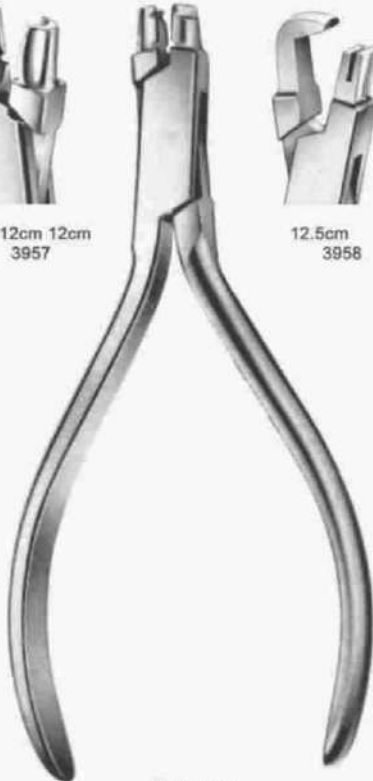

Schwarz
12cm



12.5cm
3958



Peeso
15cm
3959



14cm
3960



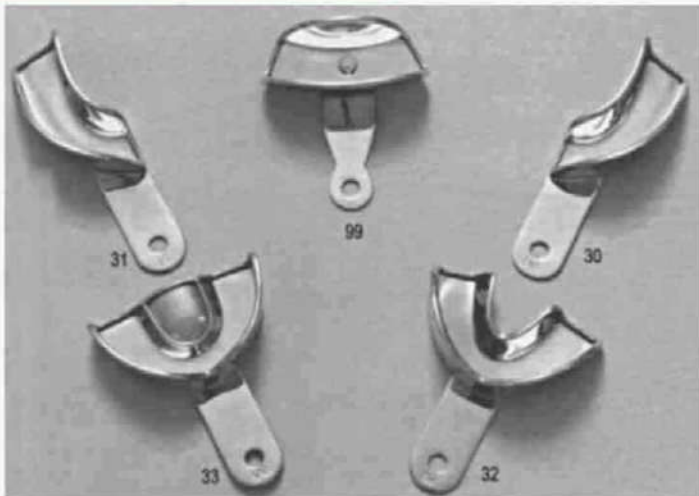

3975 (99-30-31) SET OF 3
3976 (32-33) SET OF 2
3977-30
3978-31
3979-32
3980-33
3981-99

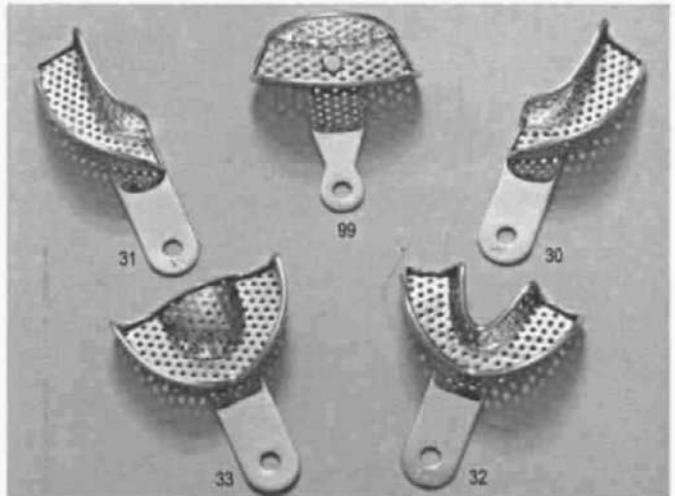

3982 (99-30-31) SET OF 3
3983 (32-33) SET OF 2
3984-30
3985-31
3986-32
3987-33
3988-99

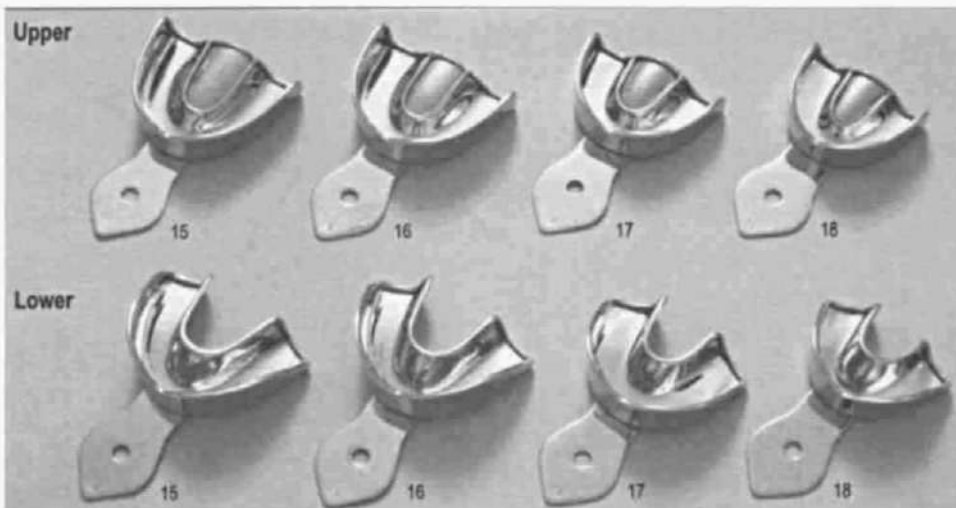

3989 SET OF 8
3990-15-U
3991-16-U
3992-17-U
3993-18-U

3994-15-L
3995-16-L
3996-17-L
3997-18-L

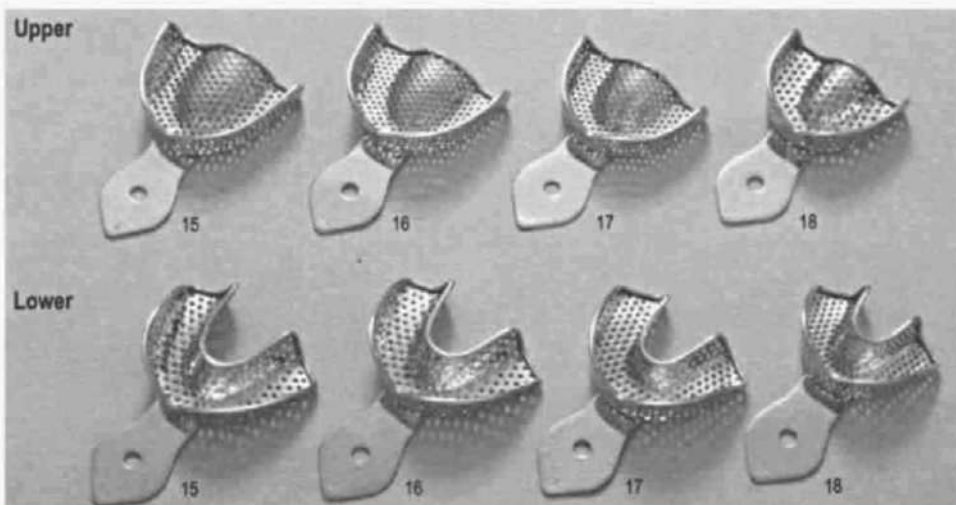

3998 SET OF 8
3999-15-U
4000-16-U
4001-17-U
4002-18-U

4003-15-L
4004-16-L
4005-17-L
4006-18-L

IMPRESSION & PARTIAL TRAY SS

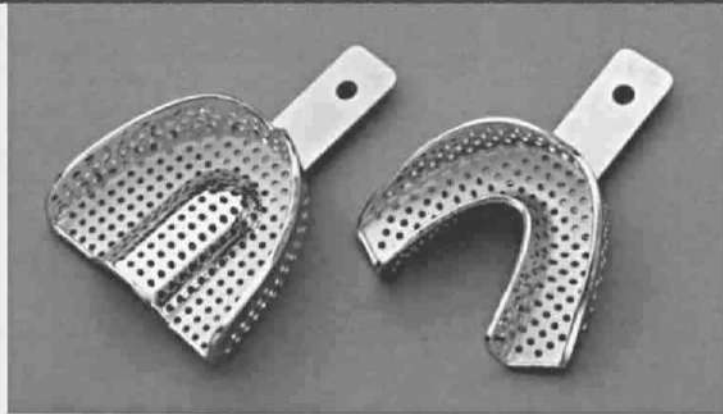

4007	SIZES / MISURE / GRANDEURS / TAMANÖS (mm)					
	U1 XXS	U2 XS	U3 S	U4 M	U5 L	U6 XL
	63	65	68	71	73	78
	48	52	54	58	59	63

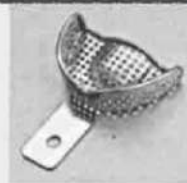

4020



4022



4021



4023

4007	SIZES / MISURE / GRANDEURS / TAMANÖS (mm)					
	L1 XXS	L2 XS	L3 S	L4 M	L5 L	L6 XL
	56	66	70	73	76	78
	44	50	52	56	58	60

- 4007-SET OF 12
- 4008-U1
- 4009-U2
- 4010-U3
- 4011-U4
- 4012-U5
- 4013-U6
- 4014-L1
- 4015-L2
- 4016-L3
- 4017-L4
- 4018-L5
- 4019-L6

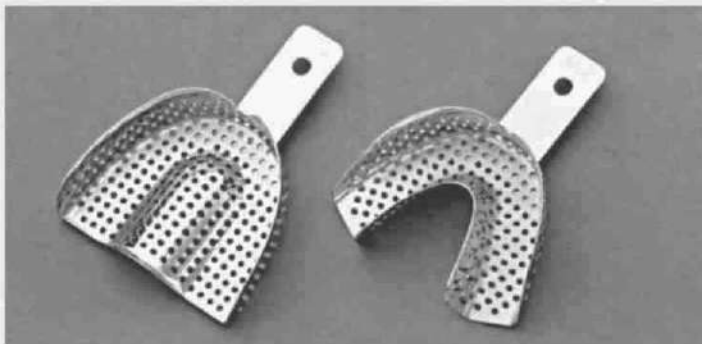

4033

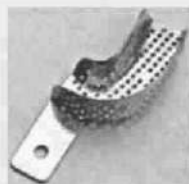

4034



- 4020-SET OF 12
- 4021-U1
- 4022-U2
- 4023-U3
- 4024-U4
- 4025-U5
- 4026-U6
- 4027-L1
- 4028-L2
- 4029-L3
- 4030-L4
- 4031-L5
- 4032-L6

4020	SIZES / MISURE / GRANDEURS / TAMANÖS (mm)					
	U1 XXS	U2 XS	U3 S	U4 M	U5 L	U6 XL
	63	65	68	71	73	78
	48	52	54	58	59	63

4020	SIZES / MISURE / GRANDEURS / TAMANÖS (mm)					
	L1 XXS	L2 XS	L3 S	L4 M	L5 L	L6 XL
	56	66	70	73	76	78
	44	50	52	56	58	60



4048



4050



4049



4051

4035	SIZES / MISURE / GRANDEURS / TAMANÖS (mm)					
	U1 XXS	U2 XS	U3 S	U4 M	U5 L	U6 XL
	63	65	68	71	73	78
	48	52	54	58	59	63

4035	SIZES / MISURE / GRANDEURS / TAMANÖS (mm)					
	L1 XXS	L2 XS	L3 S	L4 M	L5 L	L6 XL
	56	66	70	73	76	78
	44	50	52	56	58	60

- 4035-SET OF 12
- 4036-U1
- 4037-U2
- 4038-U3
- 4039-U4
- 4040-U5
- 4041-U6
- 4042-L1
- 4043-L2
- 4044-L3
- 4045-L4
- 4046-L5
- 4047-L6

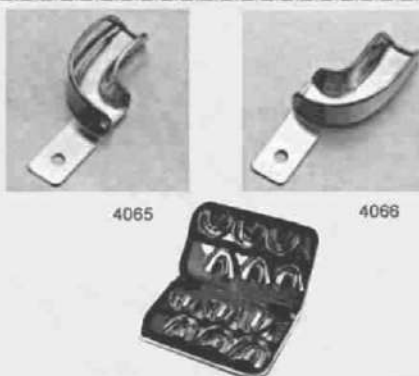
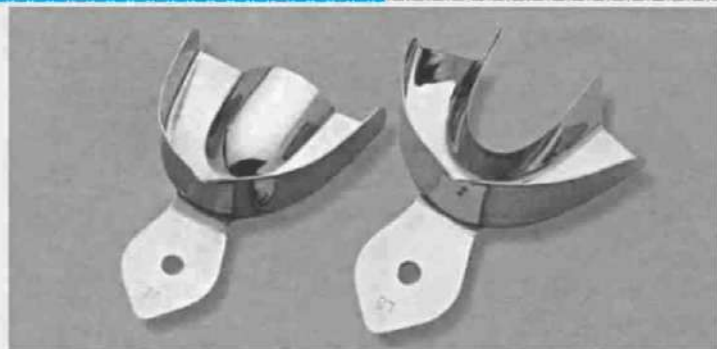

4052-SET OF 12
4053-U1
4054-U2
4055-U3
4056-U4
4057-U5
4058-U6

4059-L1
4060-L2
4061-L3
4062-L4
4063-L5
4064-L6



4052	SIZES / MISURE / GRANDEURS / TAMANÓS (mm)					
	U1 XXS	U2 XS	U3 S	U4 M	U5 L	U6 XL
	63	65	68	71	73	78
	48	52	54	58	59	63

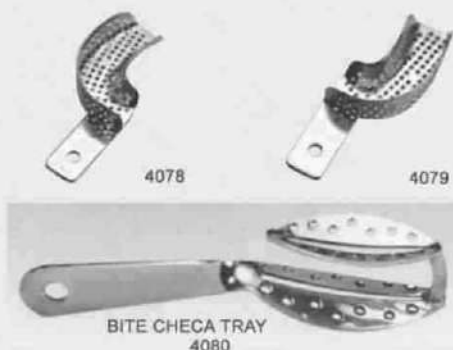

4052	SIZES / MISURE / GRANDEURS / TAMANÓS (mm)					
	L1 XXS	L2 XS	L3 S	L4 M	L5 L	L6 XL
	56	66	70	73	76	78
	44	50	52	56	58	60







4067-SET OF 10
4068-U1
4069-U2
4070-U3
4071-U4
4072-U5

4073-L1
4074-L2
4075-L3
4076-L4
4077-L5

4067	SIZES / MISURE / GRANDEURS / TAMANÓS (mm)				
	U1 XXS	U2 XS	U3 S	U4 M	U5 L
	60	63	68	69	78
	51	52	58	59	63





4067	SIZES / MISURE / GRANDEURS / TAMANÓS (mm)					
	L1 XXS	L2 XS	L3 S	L4 M	L5 L	L6 XL
	60	67	70	74	75	79
	51	52	54	55	55	56



4081	SIZES / MISURE / GRANDEURS / TAMANÓS (mm)					
	U1 XXS	U2 XS	U3 S	U4 M	U5 L	
	60	63	68	69	78	
	51	52	58	59	63	
4081	L1 XXS	L2 XS	L3 S	L4 M	L5 L	L6 XL
	60	67	70	74	75	79
	51	52	54	55	55	56

4081-SET OF 10
4082-U1
4083-U2
4084-U3
4085-U4
4086-U5





4087-L1
4088-L2
4089-L3
4090-L4
4091-L5

4092	SIZES / MISURE / GRANDEURS / TAMANÓS (mm)					
	U1 XXS	U2 XS	U3 S	U4 M	U5 L	
	60	63	68	69	78	
	51	52	58	59	63	
4092	L1 XXS	L2 XS	L3 S	L4 M	L5 L	L6 XL
	60	67	70	74	75	79
	51	52	54	55	55	56

4092-SET OF 10
4093-U1
4094-U2
4095-U3
4096-U4
4097-U5

4098-L1
4099-L2
4100-L3
4101-L4
4102-L5







4103	SIZES / MISURE / GRANDEURS / TAMANOS (mm)			
	U1 S	U2 M	U3 L	U4 XL
	64	65	73	76
	68	58	58	57
4103	L1 S	L2 M	L3 L	L4 XL
	66	72	76	82
	54	56	60	61

4103-SET OF 8
4104-U1
4105-U2
4106-U3
4107-U4

4108-L1
4109-L2
4110-L3
4111-L4





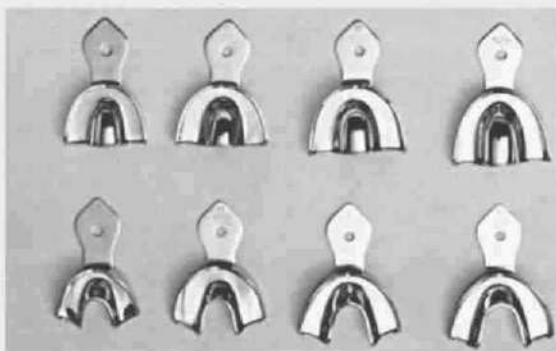

4112	SIZES / MISURE / GRANDEURS / TAMANOS (mm)			
	U1 S	U2 M	U3 L	U4 XL
	65	66	72	77
	58	63	61	68
4112	L1 S	L2 M	L3 L	L4 XL
	65	72	75	83
	56	60	61	62

4112-SET OF 8
4113-U1
4114-U2
4115-U3
4116-U4

4117-L1
4118-L2
4119-L3
4120-L4





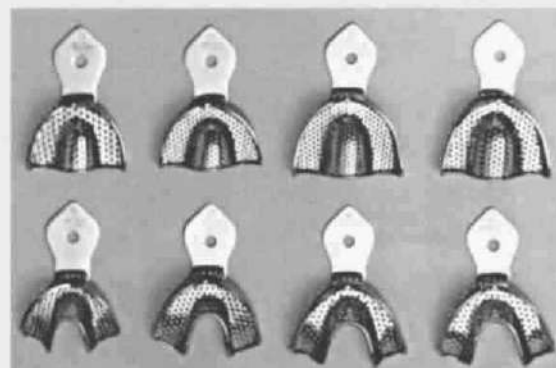

4121	SIZES / MISURE / GRANDEURS / TAMANOS (mm)			
	U1 S	U2 M	U3 L	U4 XL
	52	58	59	60
	41	42	49	50
4121	L1 S	L2 M	L3 L	L4 XL
	57	62	69	70
	42	48	49	50

4121-SET OF 8
4122-U1
4123-U2
4124-U3
4125-U4

4126-L1
4127-L2
4128-L3
4129-L4



4130	SIZES / MISURE / GRANDEURS / TAMANOS (mm)			
	U1 S	U2 M	U3 L	U4 XL
	52	58	59	60
	41	42	49	50
4130	L1 S	L2 M	L3 L	L4 XL
	57	62	69	70
	42	48	49	50

4130-SET OF 8
4131-U1
4132-U2
4133-U3
4134-U4

4135-L1
4136-L2
4137-L3
4138-L4



4139



4140



4141

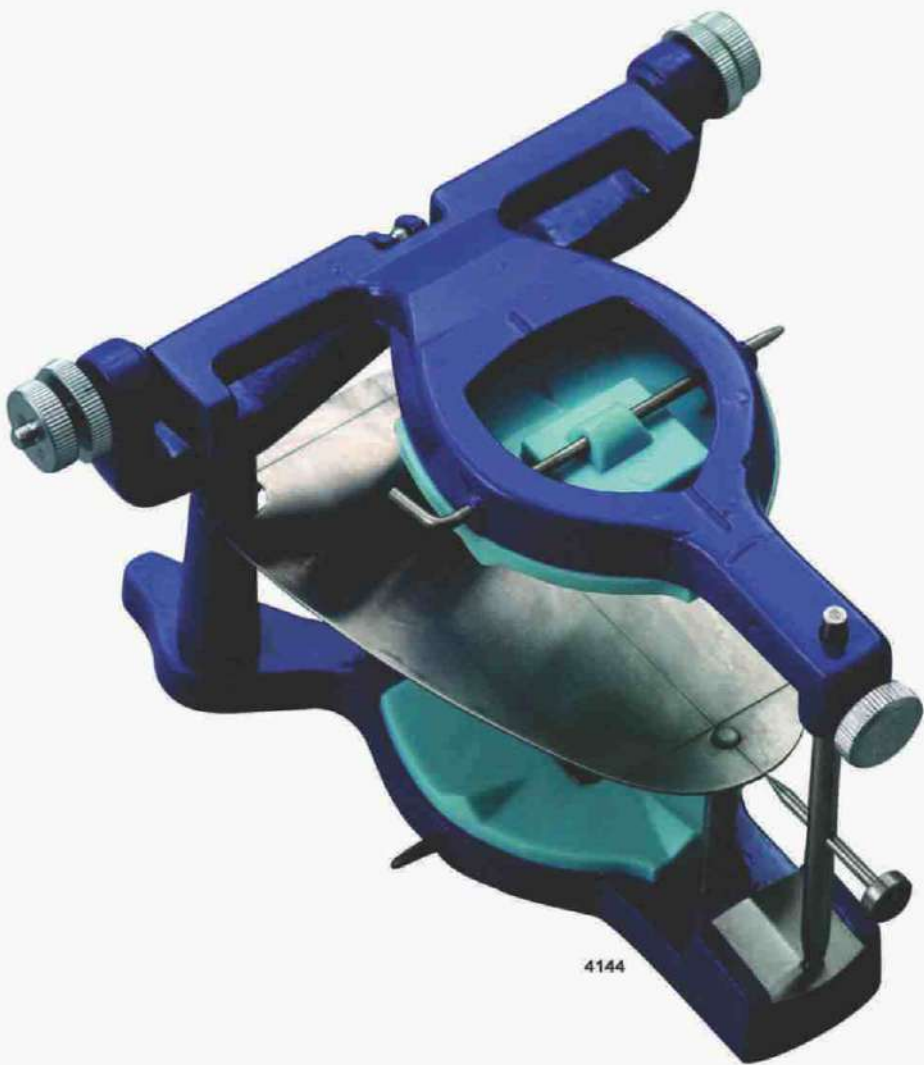

4144



4142



4143





CATHETER TRAY

4163	220×80×35m/m
4164	450×120×60m/m



INSTRUMENT TRAY

4165	370×270×75m/m
4166	320×200×55m/m
4167	255×165×50m/m
4168	230×130×45m/m



INSTRUMENT TRAY

4169	320×200×55m/m
4170	255×165×50m/m
4171	230×130×45m/m



COMPARTMENTED TRAY (D/P TRAY)

72	225×130×20m/m
----	---------------



INSTRUMENT TRAY

4173	225×125×50m/m
4174	225×165×50m/m
4175	310×195×55m/m
4176	415×250×65m/m
4177	510×325×65m/m



INSTRUMENT TRAY

4178	530×430×80m/m
4179	360×320×60m/m
4180	280×220×55m/m
4181	210×170×25m/m



PERFORATED STERILIZATION TRAY

4182	360 × 320 × 60m/m
4183	280 × 220 × 55m/m



PORFORATED STERILIZATION TRAY

-4184	230 × 130 × 45m/m
-4185	255 × 165 × 50m/m
-4186	320 × 200 × 55m/m
-4187	415 × 250 × 65m/m
-4188	510 × 325 × 65m/m



MEDICINE TRAY

4189	350 × 225 × 16m/m
4190	480 × 325 × 18m/m



EMESIS BASIN

-4191	200m/m
-4192	250m/m



Dental Instruments Trays
150x100x10 mm



SOLUTION BOWL

4196	295 × 105m/m	5 1/8 qt.
4197	315 × 115m/m	6qt.
4198	355 × 120m/m	7qt.
4199	380 × 125m/m	8 1/2 qt.



SPONGE BOWL

4200	40×25m/m	#1
4201	55×28m/m	#2
4202	65×35m/m	#3
4203	80×40m/m	#4
4204	90×45m/m	#5
4205	105×50m/m	#6
4206	125×55m/m	#7
4207	145×60m/m	#8
4208	165×70m/m	#9



DRESSING JAR

4209	75×60m/m
4210	88×90m/m
4211	120×115m/m
4212	135×132m/m
4213	165×160m/m

**OINTMENT JAR
4209**



FORCEP JAR

4218	55×130m/m
4219	55×160m/m
4220	55×190m/m



STERILIZING DRUM

4214	150m/m×120m/m
4215	185m/m×140m/m
4216	245m/m×170m/m
4217	275m/m×185m/m



EDNDO BOX AND HOLDER



COTTON HOLDER



ALCOHOL BURNERS



SICOP

Surgical Instruments
Co. of Pak



EMAIL ADDRESS

info@sicopinstruments.com
sales@sicopinstruments.com



PHONE NUMBER

+923008719689
+923404512818



ADDRESS

6-7B, M A Jinnah Road Small
Industries Estate
Sialkot Punjab Pakistan

