

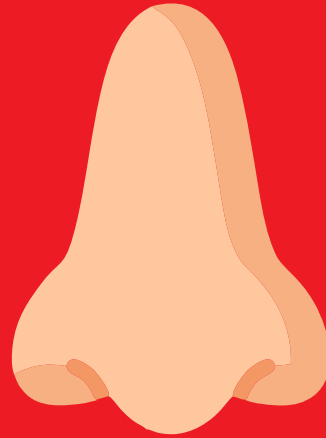

SICOP

Surgical Instrument Company of Pakistan



EAR NOSE THROAT

Catalogue

CONTENTS

GENERAL INSTRUMENTS

Page



SCALPEL HANDLES	5
SCISSORS	5
NEEDLE HOLDERS	5
DISSECTING FORCEPS	6
ARTERY FORCEPS	6
SUTURE CARRIERS	7
TROCARS	7
SUCTION TUBES	7

AURAL (EAR) INSTRUMENTS



HOOKS	8
MYRINGOTOMES	8
PROBES	8
SPECULA	8
CROCODILE FORCEPS	9
PICKS	9

NASAL INSTRUMENTS



PUNCHES	10
DRESSING FORCEPS	10
ELEVATORS	10
CARTILAGE KNIVES	11
SNARES	11
SPECULA	12, 13
TURBINATE FORCEPS	13

ORAL (MOUTH) INSTRUMENTS



MOUTH GAGS	14
BIPODS & PLATES	15
TONSIL DISSECTORS	15
TONSIL HOLDING FORCEPS	15
ADENOID CURETTES	16
TONSIL SNARES	16
GOUGES	17
MALLETS	17
SYRINGES	17
DIATHERMY NEEDLES & CABLES	18
BIPOLAR FORCEPS & CABLES	18

RECOMMENDED E.N.T. INSTRUMENT SETS

In conjunction with some of Our leading E.N.T. consultants, we have prepared a small selection of recommended sets for use in common E.N.T. procedures. These are by no means an exhaustive list of either the ear, nose and throat instruments that we produce or the sets we can provide. They should however, provide a guideline for common procedures.

TONSILLECTOMY & ADENOIDECTOMY TRAY

	Page
21.860.10Yankauer Suction Tube Complete	
30.345.20Doughty Tongue Plate Slotted 2.5" (6.25cm)	14
30.345.30Doughty Tongue Plate Slotted 3" (7.5cm)	14
30.345.40Doughty Tongue Plate Slotted 3.5" (9cm)	14
30.345.50Doughty Tongue Plate Slotted 4" (10cm)	14
30.345.60Doughty Tongue Plate Slotted 4.5" (11.5cm)	14
30.300.10Davis Boyle Mouth Gag Frame Child	14
30.300.30Davis Boyle Mouth Gag Frame Adult	14
30.430.05Draffin Bipod 4 Rings 15" (Paediatric) Pair	15
30.430.10Draffin Bipod 4 Rings 19" Pair	15
30.960.30St. Clair Thomson Adenoid Curette Size 1.5 12mm x 8.5" (21.5cm)	16
30.960.40St. Clair Thomson Adenoid Curette Size 2 14mm x 8.5" (21.5cm)	16
30.960.50St. Clair Thomson Adenoid Curette Size 3 16mm x 8.5" (21.5cm)	16
30.680.20Denis Browne Tonsil Hold Forceps Large 8" (20cm)	15
87.660.20Timesco Bipolar Forceps Straight 7" (18cm) Broad 1.00mm	18
87.850.20Timesco Bipolar Cable 3 Meter Euro Silicon	18
12.965.20Mcindoe Scissors Curved 7" (18cm) Blunt/Blunt Tungsten Carbide	5
14.020.10Birkett Artery Forceps Straight 7.5" (19cm)	6
14.380.50Negus Artery Forceps Long Curved 7.5" (19cm)	6
30.580.10Mollison Tonsil Retractor/Dissector 8.25" (21cm)	15
28.400.10Hill Elevator & Dissector Double Ended 9" (23cm)	10
17.960.10Negus Knot Tier And Pusher 8" (20cm)	7
13.425.30Vaugh Dissecting Forceps 8" (20cm) Serrated	6
13.425.60Vaugh Dissecting Forceps 8" (20cm) 1x2 Teeth Serrated	6

INSERTION OF GROMMET & EXAMINATION UNDER ANAESTHETIC (E.U.A.) TRAY

26.813.15Gruber Speculum 3mm Diamond Oval Black	8
26.813.20Gruber Speculum 4mm Diamond Oval Black	8
26.813.25Gruber Speculum 5mm Diamond Oval Black	8
26.889.35Tumarkin Speculum No:4 Round Black Slot	8
26.675.20Jobson Horne Probe Double Ended 7" (18cm)	8
21.870.10Zoellner Suction Tube	7
21.870.30Zoellner Suction Tube End 18swg	7
27.240.40Hartman Crocodile Forceps Micro Serrated Black	9
26.130.10Formby Cerumen Scoop & Hook 7" (18cm)	8
27.320.30Ormerod Crocodile Forceps Micro Cup Black	9
27.685.50Schuknecht Pick Straight 178mm Black	9
26.560.10Agnew (Politzer) Myringotome 7" (18cm)	8

28.715.40Thudicum Nasal Speculum Set of 5	12
28.685.10Killian Nasal Speculum 2" (5cm) x 5.5" (13cm) Self Retaining	12
28.685.20Killian Nasal Speculum 2.5" (6.5cm) x 5.5" (13cm) Self Retaining	12
28.685.30Killian Nasal Speculum 3" (7.5cm) x 5.5" (13cm) Self Retaining	12
28.685.40Killian Nasal Speculum 3.5" (9cm) x 5.5" (13cm) Self Retaining	12
28.750.20Thudicum Nasal Speculum No:2 Diathermy Insulated	13
11.550.10Scalpel Handle No:3 Stainless Steel	5
28.470.80Freer Elevator Sharp & Dull Blade 7.5" (19cm) Double Ended (8)	10
28.400.10Hill Elevator/Dissector Double Ended 9" (23cm)	10
28.450.10Ballenger Nasal Knife Straight 6mm Blade 8" (20cm)	11
28.310.10Tilley Henckel Punch 4.5mm Jaw x 4.5" (11.5cm) Shaft	10
28.310.20Tilley Henckel Punch 5.5mm Jaw x 4.5" (11.5cm) Shaft	10
40.798.10Small Mallet Stainless Steel 8.5oz Smooth Head	17
40.530.20Jenkin Gouge Straight 6mm x 5.5" (14cm)	17
40.530.25Jenkin Gouge Straight 8mm x 5.5" (14cm)	17
28.805.10Luc Turbinate Forceps Oval Small 6mm x 7.5" (19cm)	13
28.805.20Luc Turbinate Forceps Oval Medium 7.5mm x 7.5" (19cm)	13
28.805.30Luc Turbinate Forceps Oval Large 9mm x 7.5" (19cm)	13
28.380.10Tilley Nasal Dressing Forceps 7" (18cm)	10
21.870.10Zoellner Suction Tube	7
21.870.35Zoellner Suction Tube End 20swg	7
21.780.30Self Clearing Suction Tube Medium	7
12.415.25Heymann Turbinectomy Scissors Angled 7" (18cm)	5
12.985.20Strabismus Scissors Curved 4.5" (11.5cm) Blunt/Blunt Tungsten Carbide	5
17.330.10Crilewood Needle Holder 6" (15.5cm) Tungsten Carbide	5
14.325.20Halstead Mosquito Artery Forceps Straight 5" (13cm) Standard	6
745.550.40Dental Cartridge (A) Syringe Self Aspirating 2.2ml	17
86.800.40Abbey Sub-Mucosal Needle Diathermy Insulated	18
86.251.20Diathermy Cable 3 Meter Pin Fitting 4mm End	18
21.200.25Tilley Litchwitz Trocar Complete 7.5fg	7
21.200.65Tilley Litchwitz Cannula Only 7.5fg	7
28.620.10Glegg Nasal Snare Self Forming 9" (23cm)	11
28.635.10Negus Nasal Snare 9" (23cm)	11
13.225.10Gillies Dissecting Forceps 6" (15.5cm) 1x2 Teeth Serrated	6
13.295.10Mcindoe Dissecting Forceps 6" (15.5cm) Serrated	6



11.550.10 SCALPEL HANDLE No.3 STAINLESS STEEL

11.550.30 SCALPEL HANDLE No.4 STAINLESS STEEL (NOT ILLUSTRATED)

General Instru

SCISSORS

12.415.25 HEYMANN TURBINECTOMY SCISSORS ANGLED 7" (18CM)

12.965.20 MCINDOE SCISSORS CURVED 7" (18CM) BLUNT/BLUNT T.C.

12.985.20 STRABISMUS SCISSORS CURVED 4.5" (11.5CM) BLUNT/BLUNT T.C.

12.985.10 STRABISMUS SCISSORS STRAIGHT 4.5" (11.5CM) BLUNT/BLUNT T.C. (NOT ILLUSTRATED)

General Instru

NEEDLEHOLDERS

17.330.10 CRILEWOOD NEEDLEHOLDER 6" (15CM) T.C.

5.10 GILLIES DISSECTING FORCEPS 6" (15.5CM) 1X2 TEETH SERRATED

6.10 GILLIES DISSECTING FORCEPS 6" (15.5CM) 1X2 TEETH SERRATED FINE (NOT ILLUSTRATED)

5.10 MCINDOE DISSECTING FORCEPS 6" (15.5CM) SERRATED

5.20 MCINDOE DISSECTING FORCEPS 6" (15.5CM) 1X2 TEETH (NOT ILLUSTRATED)

5.30 WAUGH DISSECTING FORCEPS 8" (20CM) SERRATED

AVAILABLE BUT NOT ILLUSTRATED

5.20 WAUGH DISSECTING FORCEPS 7" (18CM) SERRATED

5.50 WAUGH DISSECTING FORCEPS 7" (18CM) 1X2 TEETH SERRATED

5.60 WAUGH DISSECTING FORCEPS 8" (20CM) 1X2 SERRATED

General Instruments

ARTERY FORCEPS

14.020.10 BIRKETT ARTERY FORCEPS STRAIGHT 7.5" (19CM)

14.020.20 BIRKETT ARTERY FORCEPS CURVED 7.5" (19CM) (NOT ILLUSTRATED)

5.20 HALSTEAD MOSQUITO ARTERY FORCEPS STRAIGHT 5" (13CM) STANDARD

5.40 HALSTEAD MOSQUITO ARTERY FORCEPS CURVED 5" (13CM) STANDARD (NOT ILLUSTRATED)

14.380.50 NEGUS ARTERY FORCEPS LONG CURVED 7.5" (19CM)

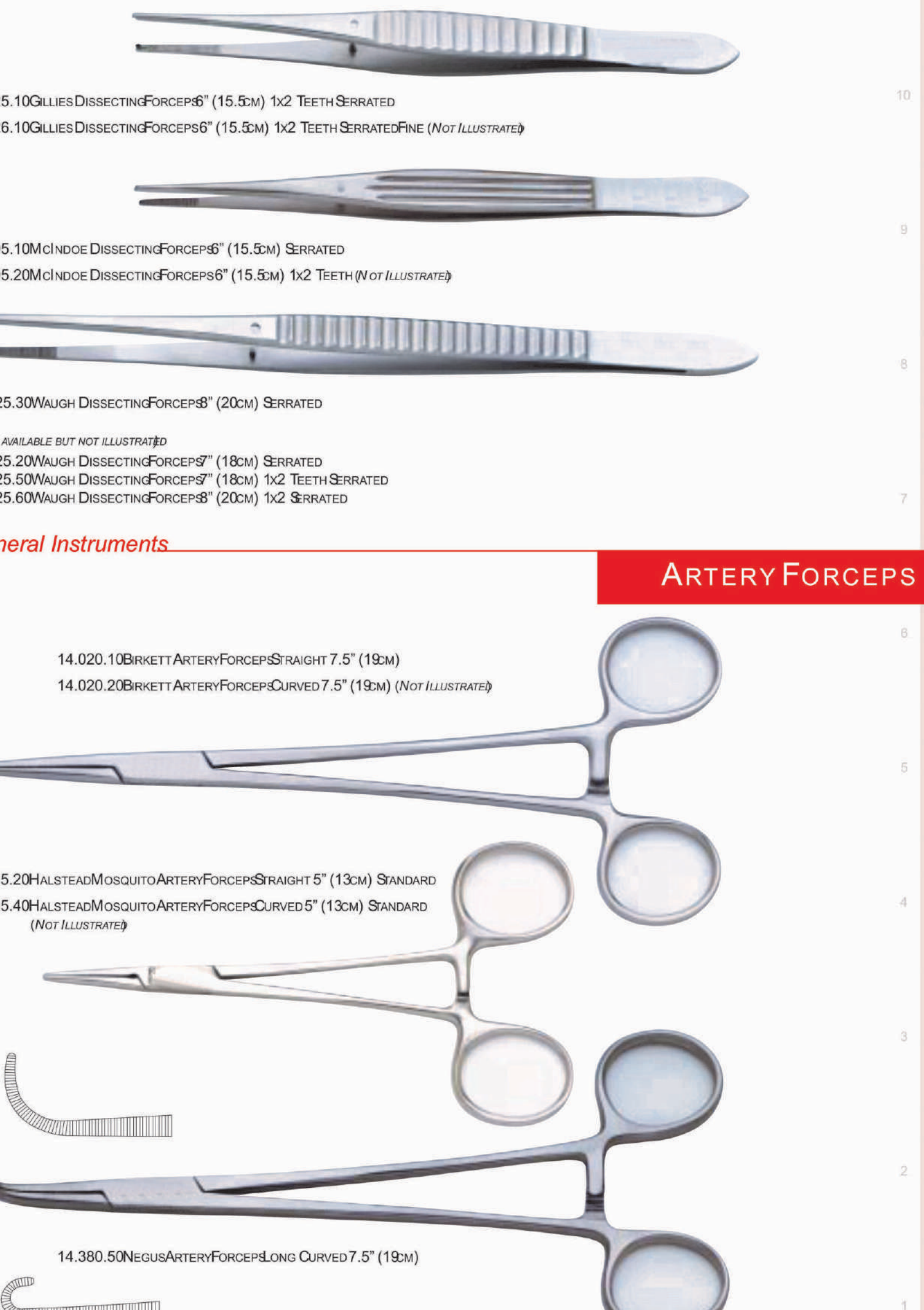

10
9
8
7
6
5
4
3
2
1

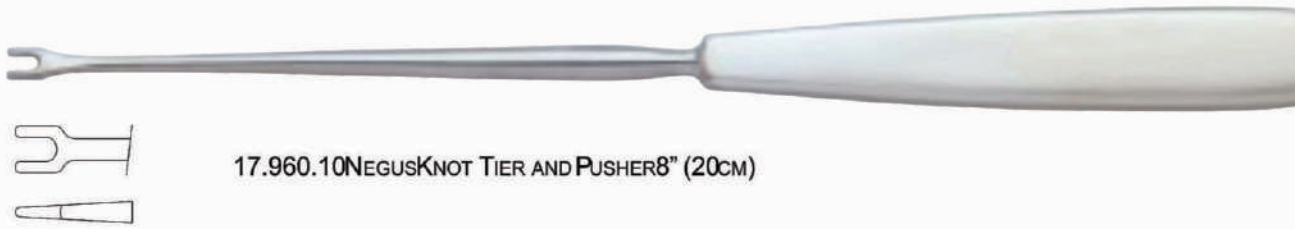

17.960.10 NEGUS KNOT TIER AND PUSHER 8" (20cm)

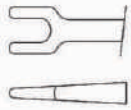

General Instru

TROCARS



21.200.25 TILLEY LITCHWITZ TROCAR COMPLETE 7.5FG



21.200.20 TILLEY LITCHWITZ TROCAR COMPLETE 7FG (NOT ILLUSTRATED)

General Instru

SUCTION TUBES

21.780.20 - Small 21.780.30 - Medium 21.780.40 - Large

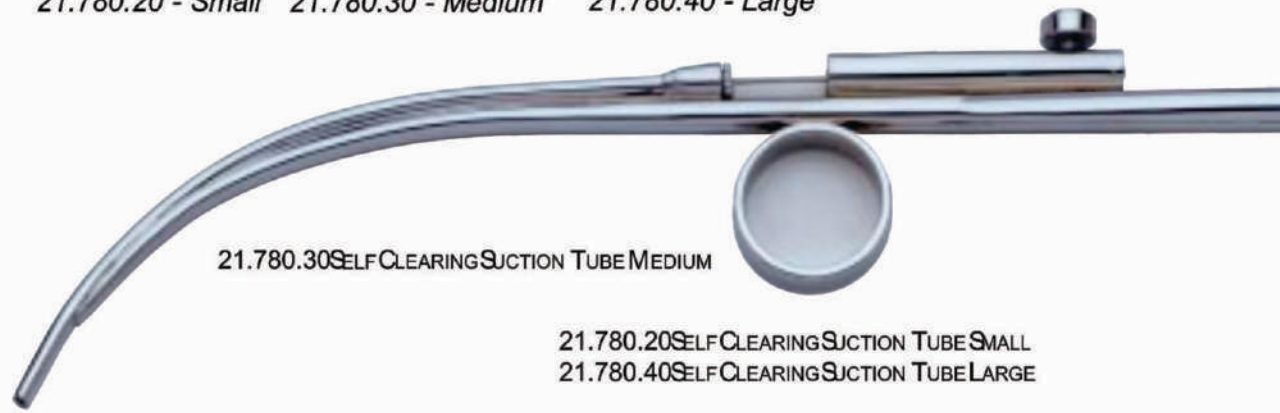

21.780.30 SELF-CLEARING SUCTION TUBE MEDIUM

21.780.20 SELF-CLEARING SUCTION TUBE SMALL
21.780.40 SELF-CLEARING SUCTION TUBE LARGE

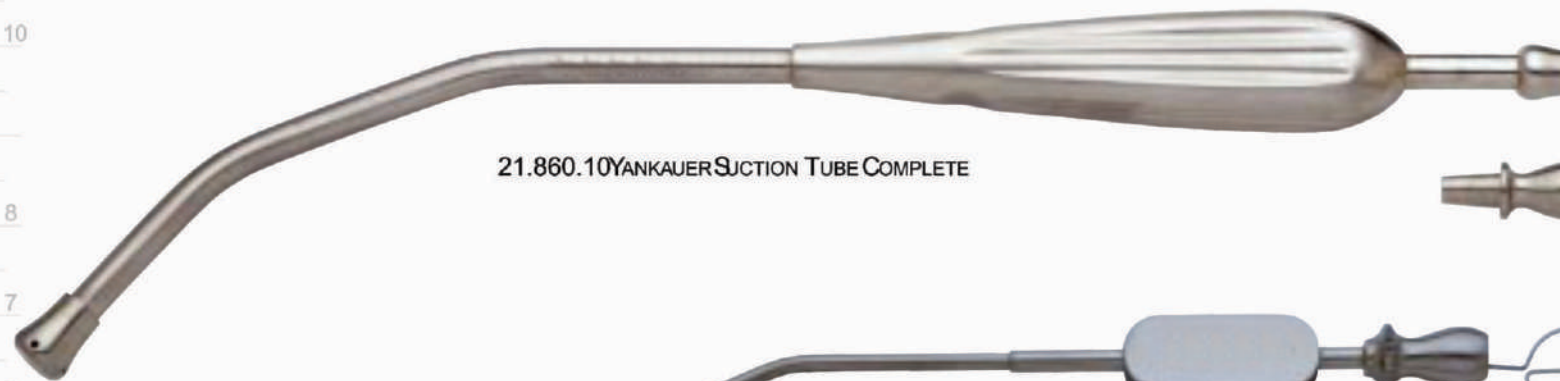

21.860.10 YANKAUER SUCTION TUBE COMPLETE

21.870.10

21.870.10 ZOELLNER SUCTION TUBE

21.870.30 ZOELLNER SUCTION TUBE END 18SWG

21.870.35 ZOELLNER SUCTION TUBE END 20SWG

21.870.40 ZOELLNER SUCTION TUBE END 22SWG

21.870.45 ZOELLNER SUCTION TUBE END 24SWG





26.560.10AGNEW (POLITZER) MYRINGOTOME 7" (18CM)



26.130.10FORMBY CERUMEN SCOOP+ HOOK 7" (18CM)



26.675.20JOBSON HORNE PROBE DOUBLE ENDED 7" (18CM)

al (Ear) Instruments

SPECULA



26.813.10GRUBER SPECULUM SET OF 4 OVAL BLACK

- 26.813.13GRUBER SPECULUM 2MM OVAL BLACK
- 26.813.15GRUBER SPECULUM 3MM OVAL BLACK
- 26.813.20GRUBER SPECULUM 4MM OVAL BLACK
- 26.813.25GRUBER SPECULUM 5MM OVAL BLACK
- 26.813.30GRUBER SPECULUM 7MM OVAL BLACK



26.889.10TUMARKIN SPECULUM SET OF 8, 0-7 ROUND BLACK SLOT

- 26.889.15TUMARKIN SPECULUM No.0 ROUND BLACK SLOT
- 26.889.20TUMARKIN SPECULUM No.1 ROUND BLACK SLOT
- 26.889.25TUMARKIN SPECULUM No.2 ROUND BLACK SLOT
- 26.889.30TUMARKIN SPECULUM No.3 ROUND BLACK SLOT
- 26.889.35TUMARKIN SPECULUM No.4 ROUND BLACK SLOT
- 26.889.40TUMARKIN SPECULUM No.5 ROUND BLACK SLOT
- 26.889.45TUMARKIN SPECULUM No.6 ROUND BLACK SLOT
- 26.889.50TUMARKIN SPECULUM No.7 ROUND BLACK SLOT



27
26
25
24
23
22
21
20
19
18
17
16
15
14
13
12
11
10
8
7
6
5
4
3



27.240.40 HARTMAN CROCODILE MICRO SERRATED BLACK



27.245.40 HARTMAN CROCODILE SUPER FINE SERRATED BLACK



27.246.40 HARTMAN CROCODILE EXTRA SUPER FINE SERRATED BLACK



27.320.30 ORMEROD CROCODILE MICRO CUP BLACK

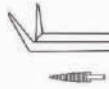

27.320.20 ORMEROD CROCODILE MICRO SERRATED UP BLACK



27.320.40 ORMEROD CROCODILE MICRO ELONGATED CUP BLACK



27.320.50 ORMEROD CROCODILE MICRO SCISSORS BLACK



27.685.50 SCHUKNECHT PICK STRAIGHT 178MM BLACK

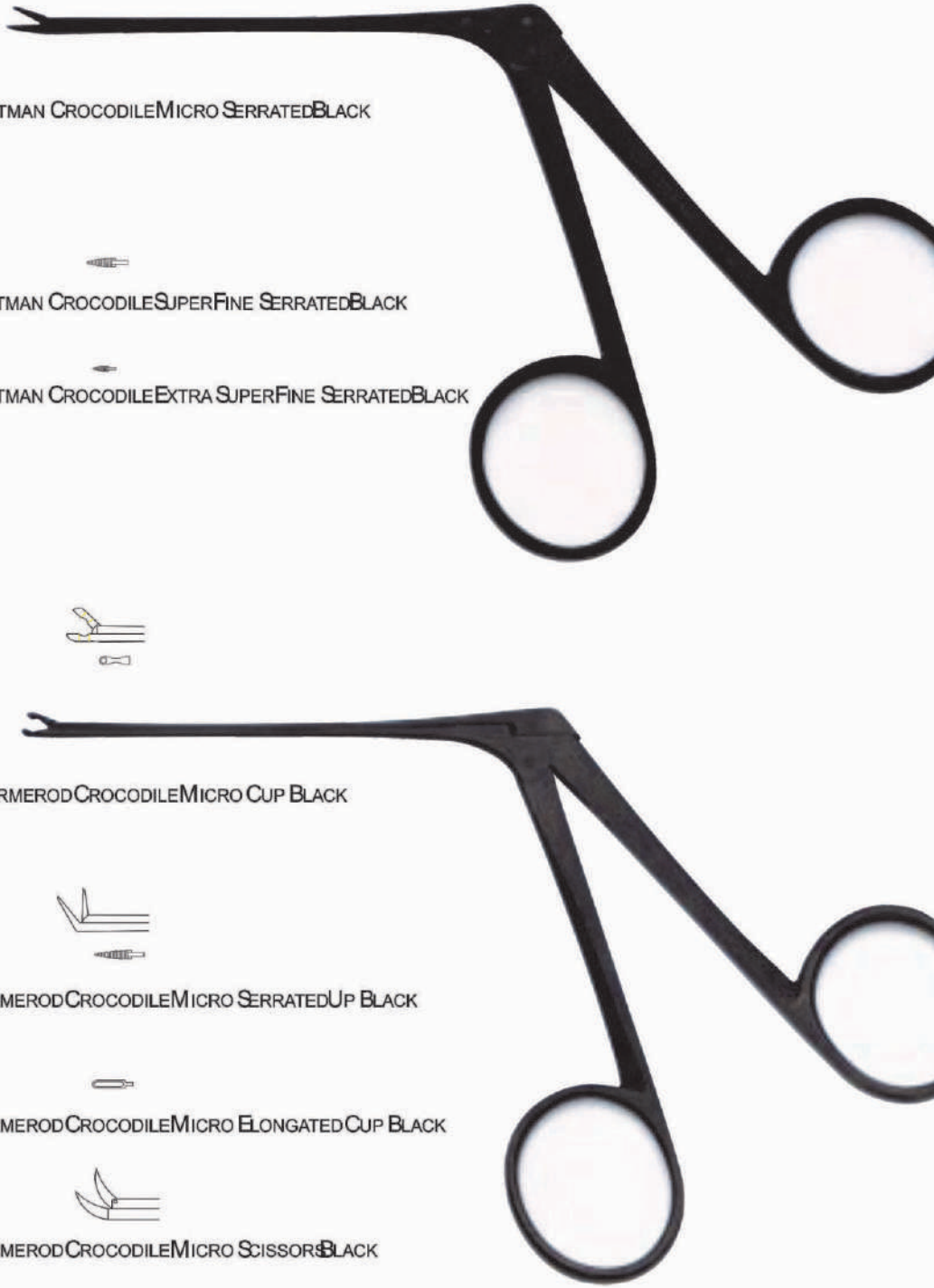

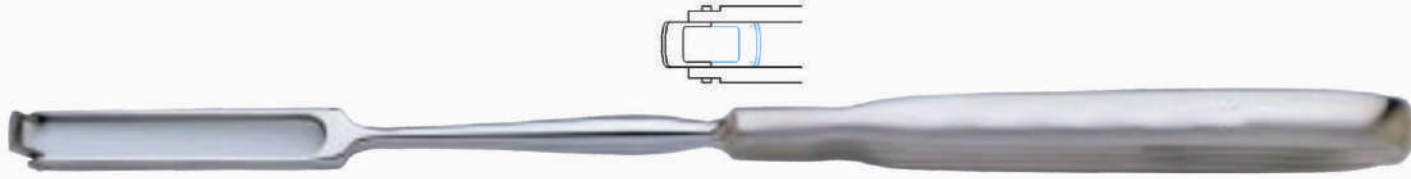

28.450.10 **BALLENGER NASAL KNIFE STRAIGHT 8" (20CM) 6MM BLADE**

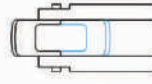

28.450.05 **BALLENGER NASAL KNIFE STRAIGHT 8" (20CM) 4MM BLADE**

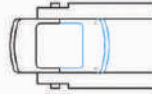

28.450.20 **BALLENGER NASAL KNIFE STRAIGHT 8" (20CM) 8MM BLADE**

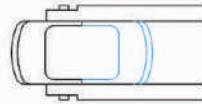

28.450.30 **BALLENGER NASAL KNIFE ANGLED 8" (20CM) 6MM BLADE**

Nasal Instru

NASAL SNARES



28.620.10 **GLEGG NASAL SNARE SELF FORMING 9" (23CM)**



28.635.10 **NEGUS NASAL SNARE 9" (23CM)**



28.685.10 KILLIAN NASAL SPECULUM 2" (5CM) X 5.5" (13CM) SELF RETAINING

28.685.20 KILLIAN NASAL SPECULUM 2.5" (6.5CM) X 5.5" (13CM) SELF RETAINING

28.685.30 KILLIAN NASAL SPECULUM 3" (7.5CM) X 5.5" (13CM) SELF RETAINING

28.685.40 KILLIAN NASAL SPECULUM 3.5" (9CM) X 5.5" (13CM) SELF RETAINING

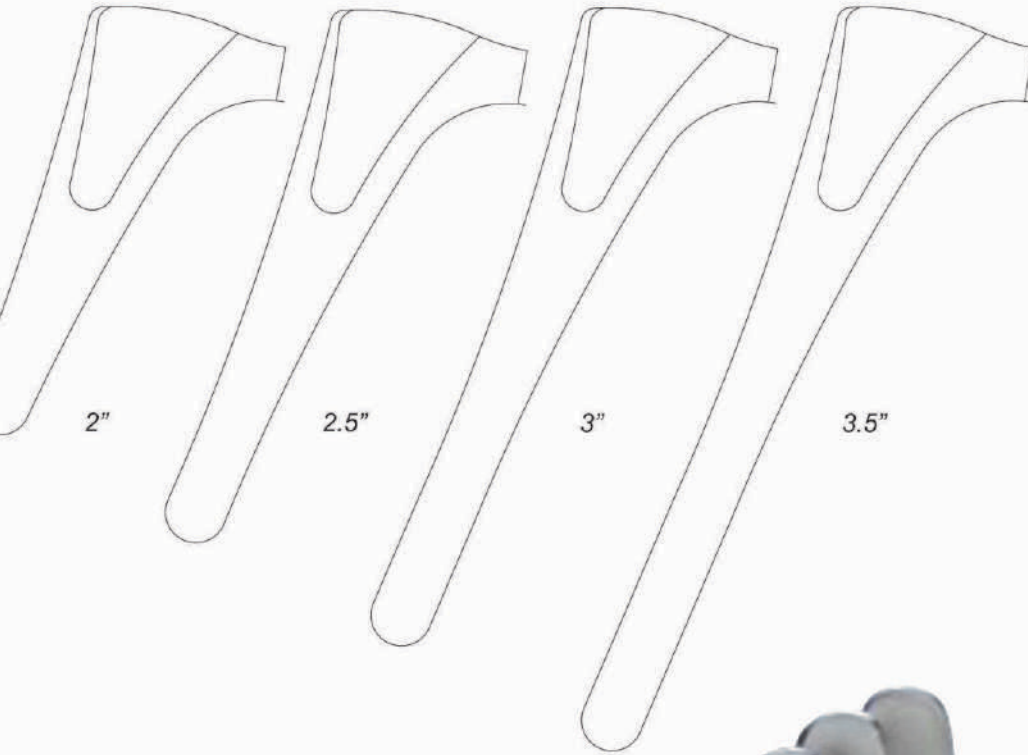

2"

2.5"

3"

3.5"

28.715.40 THUDICUM NASAL SPECULUM SET OF 5



28.715.10 THUDICUM NASAL SPECULUM No.0

28.715.15 THUDICUM NASAL SPECULUM No.1

28.715.20 THUDICUM NASAL SPECULUM No.2

28.715.25 THUDICUM NASAL SPECULUM No.3

28.715.30 THUDICUM NASAL SPECULUM No.4

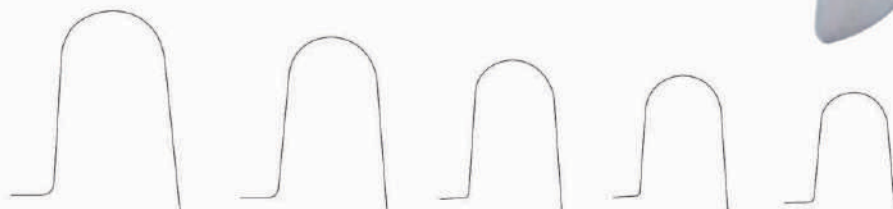

28.750.20 THUDICUM NASAL SPECULUM No.2 INSULATED

28.750.10 THUDICUM NASAL SPECULUM No.0 INSULATED
28.750.15 THUDICUM NASAL SPECULUM No.1 INSULATED
28.750.25 THUDICUM NASAL SPECULUM No.3 INSULATED
28.750.30 THUDICUM NASAL SPECULUM No.4 INSULATED
28.750.50 THUDICUM NASAL SPECULUM SET OF 5 INSULATED



28.690.10 MARK HOVELL NASAL SPECULUM No:1
28.690.15 MARK HOVELL NASAL SPECULUM No:2
28.690.20 MARK HOVELL NASAL SPECULUM No:3
28.690.25 MARK HOVELL NASAL SPECULUM No:4
28.690.30 MARK HOVELL NASAL SPECULUM No:5
28.690.35 MARK HOVELL NASAL SPECULUM No:6
28.690.40 MARK HOVELL NASAL SPECULUM No:7
28.690.50 MARK HOVELL NASAL SPECULUM SET OF 7

28.740.10 MARK HOVELL NASAL SPECULUM No.1 INSULA
28.740.15 MARK HOVELL NASAL SPECULUM No.2 INSULA
28.740.20 MARK HOVELL NASAL SPECULUM No.3 INSULA
28.740.25 MARK HOVELL NASAL SPECULUM No.4 INSULA
28.740.30 MARK HOVELL NASAL SPECULUM No.5 INSULA
28.740.35 MARK HOVELL NASAL SPECULUM No.6 INSULA
28.740.40 MARK HOVELL NASAL SPECULUM No.7 INSULA
28.740.60 MARK HOVELL NASAL SPECULUM SET OF 7 INS

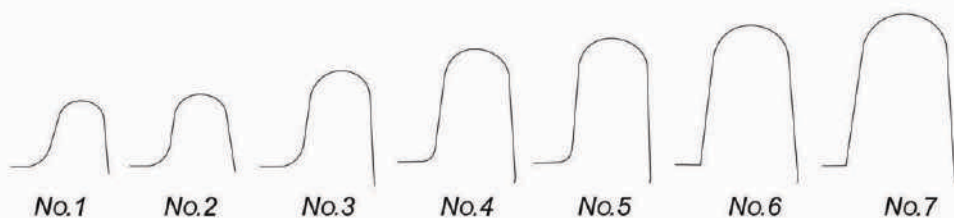

MARK HOVELL SIZES

No.1 No.2 No.3 No.4 No.5 No.6 No.7

Nasal Instrum

TURBINATE FORCEPS

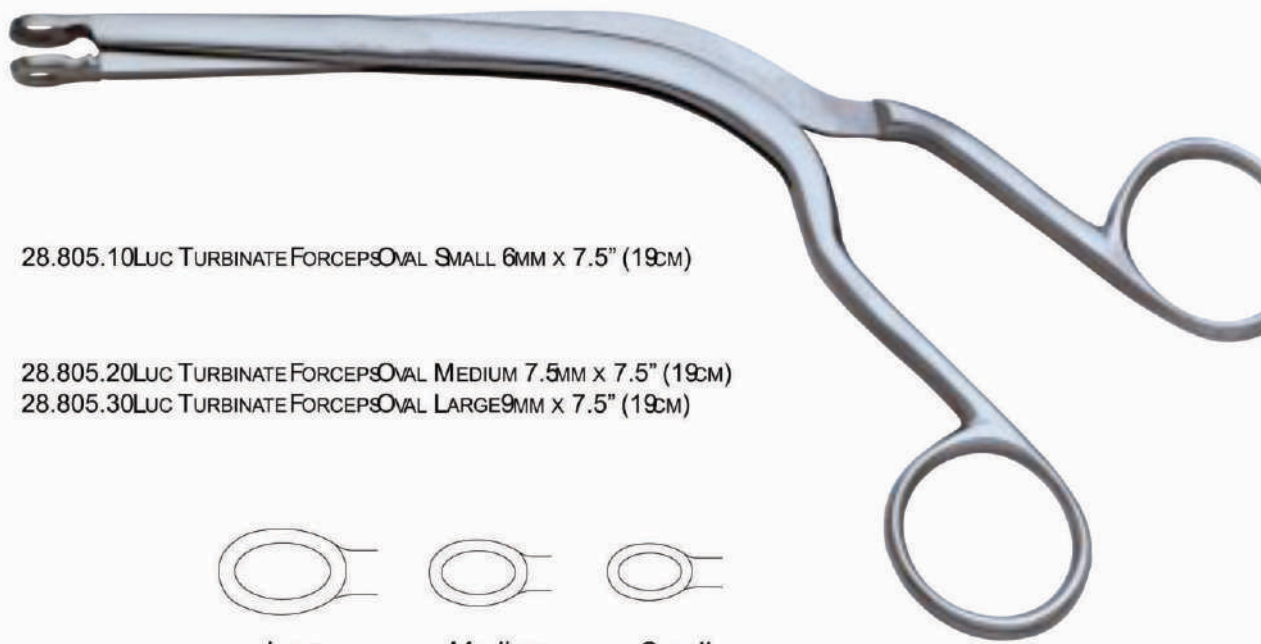

28.805.10 LUC TURBINATE FORCEPS OVAL SMALL 6MM X 7.5" (19CM)

28.805.20 LUC TURBINATE FORCEPS OVAL MEDIUM 7.5MM X 7.5" (19CM)

28.805.30 LUC TURBINATE FORCEPS OVAL LARGE 9MM X 7.5" (19CM)



30.300.10 DAVIS BOYLE MOUTH GAG FRAME CHILD

30.300.30 DAVIS BOYLE MOUTH GAG FRAME ADULT (NOT ILLUSTRATED)



15.20 DOUGHTY TONGUE PLATE 2.5" (6.25CM) WITH 2MM SLOT

15.30 DOUGHTY TONGUE PLATE 3" (7.5CM) WITH 3MM SLOT

15.40 DOUGHTY TONGUE PLATE 3.5" (9CM) WITH 5.7MM SLOT

15.50 DOUGHTY TONGUE PLATE 4" (10CM) WITH 7MM SLOT

15.60 DOUGHTY TONGUE PLATE 4.5" (11.5CM) WITH 8MM SLOT

WE ALSO SUPPLY SPARE TEETH GUARDS PROTECTORS FOR MOUTH GAGS, PLEASE CONTACT US FOR DETAILS OR REFER TO OUR PRICE LIST





30.430.05 DRAFFIN BIPOD 4 RINGS 15" (38.5CM) PAIR

30.430.10 DRAFFIN BIPOD 4 RINGS 19" (48CM) PAIR (NOT ILLUSTRATED)



30.440.10 MAGAURAN PLATE 16" (40.5CM)

TONSIL DISSECTORS AND FORCEPS

Oral (mouth) Instru



30.580.10 MOLLISON TONSIL RETRACTOR/DISSECTOR 8.25" (21CM)



30.680.20 DENIS BROWNE TONSIL HOLDING FORCEPS LARGE 8" (20CM)

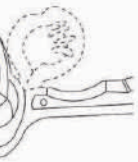

30.960.30St. CLAIR THOMSON ADENOID CURETTE 1.5 12MM X 8.5" (21.5M)

- 30.960.10St. CLAIR THOMSON ADENOID CURETTE 0 8.5"(21.5M) X 8MM
- 30.960.20St. CLAIR THOMSON ADENOID CURETTE 1 8.5"(21.5M) X 10MM
- 30.960.40St. CLAIR THOMSON ADENOID CURETTE 2 8.5"(21.5M) X 14MM
- 30.960.50St. CLAIR THOMSON ADENOID CURETTE 3 8.5"(21.5M) X 16MM
- 30.960.60St. CLAIR THOMSON ADENOID CURETTE 4 8.5"(21.5M) X 18MM

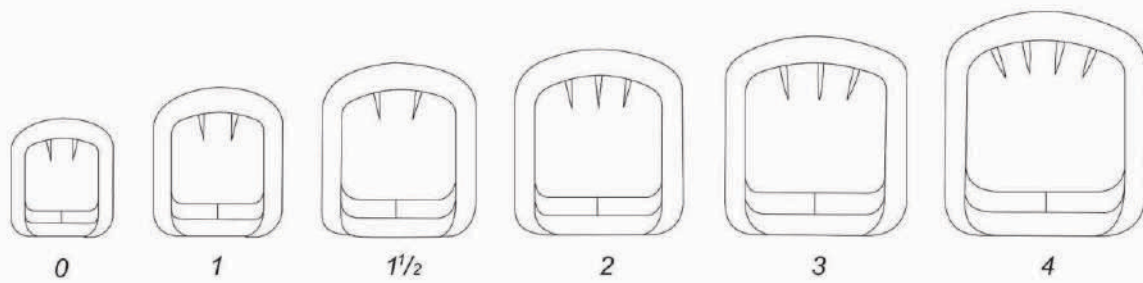

al (mouth) Instruments

TONSIL SNARE

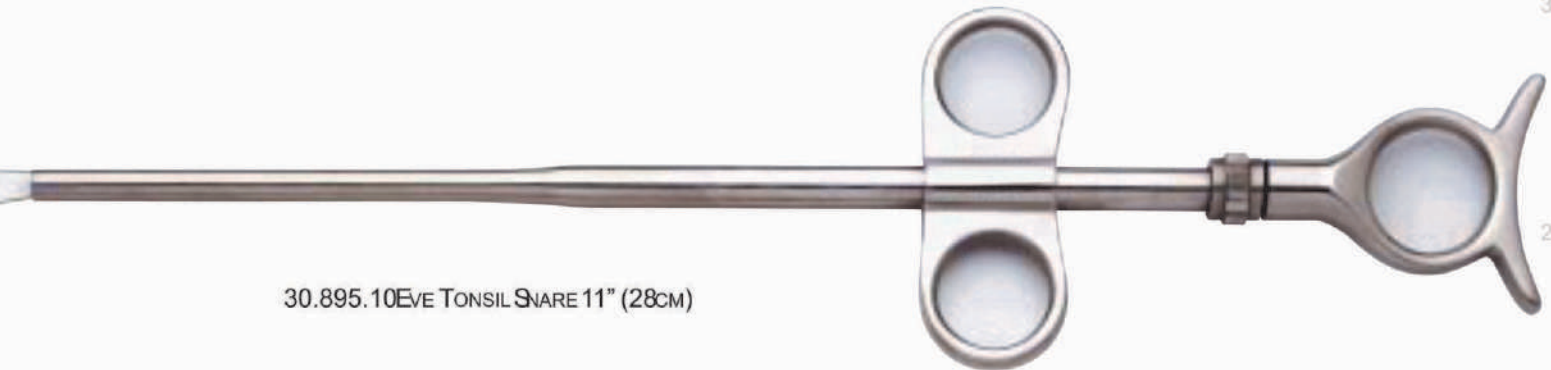

30.895.10EVE TONSIL SNARE 11" (28CM)



40.530.20 JENKIN GOUGE STRAIGHT 6MM X 5.5" (14CM)

40.530.25 JENKIN GOUGE STRAIGHT 8MM X 5.5" (14CM)



40.798.10 SMALL MALLET STAINLESS STEEL 8.5OZ SMOOTH HEAD

SYRINGES

Oral (mouth) Instru



745.550.40 DENTAL CARTRIDGE(A) SYRINGE SELF ASPIRATING 2.2ML

86.800.40 ABBEY SUB-MUCOSAL NEEDLE INSULATED

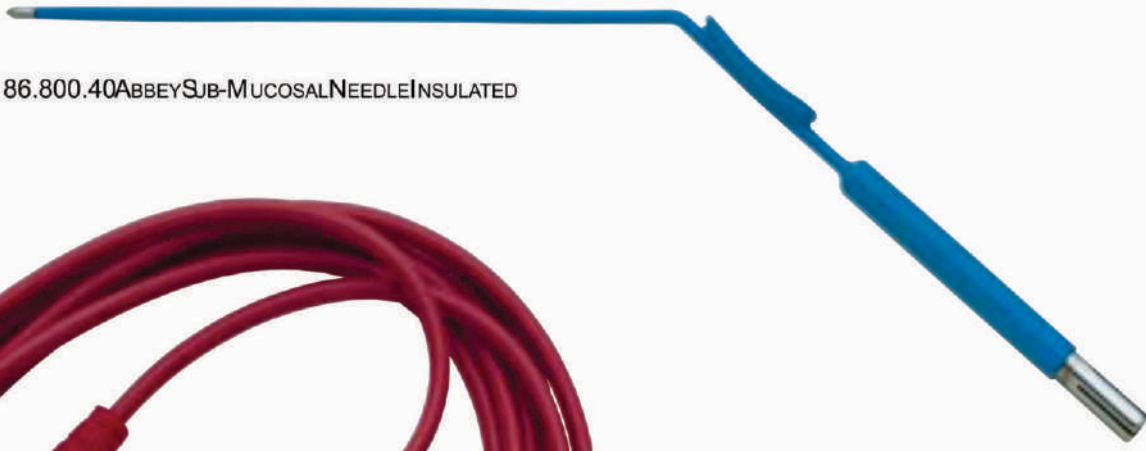

86.251.20 DIATHERMY CABLE 3 METRES PIN (4MM) END

86.251.40 DIATHERMY CABLE 3 METRES PIN (8MM) END (NOT ILLUSTRATED)

(mouth) Instruments

BIPOLAR FORCEPS & CABLES



7.660.20 TIMESCO BIPOLAR FORCEPS STRAIGHT 7" (18CM) BROAD 1.00MM TIP

7.850.20 TIMESCO BIPOLAR CABLE 3 METRES EURO SILICON





SICOP

Surgical Instrument Company of Pakistan

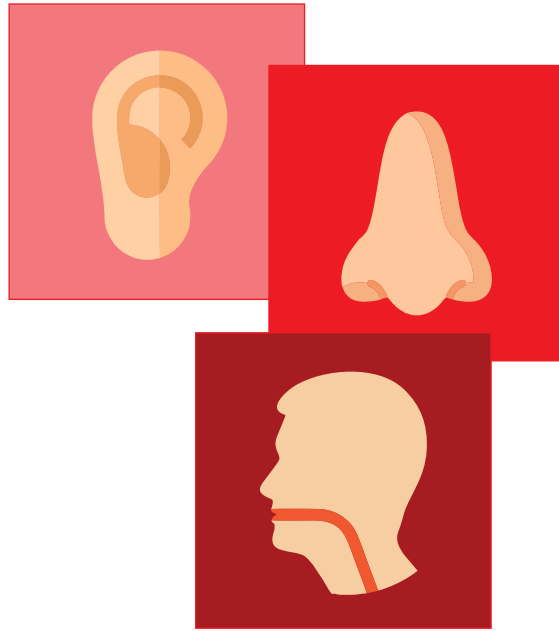

EMAIL ADDRESS

info@sicopinstruments.com
sales@sicopinstruments.com



PHONE NUMBER

+923008719689
+923404512818



ADDRESS

6-7B, M A Jinnah Road Small
Industries Estate
Sialkot Punjab Pakistan

Find Us on Google Maps

